

# FLAT

by panconnect•

**FLAT** is a basic but very universal panel that can be placed on working places, conference tables, and in conference rooms. This product can be used practically everywhere where universal connectivity plays a role. When there is a requirement for maximum modularity, low installation depth and easy installation, **FLAT** is the right choice.

**PANCONNECT** offers 5 variants of this product.

**FLAT BASIC** contains only sockets and connection modules, alternatively pull-out or pass-thru module. Three

other sizes - **FLAT M, L** and **XL** can be used depending on the connectivity requirements and number of sockets that are needed. All the panels include **USB - A and USB - C** (60W) charging slots, alternatively Qi charging that is integrated directly in the panel.

**FLAT PLUS** includes on top of that third party's active module (for size from 45 to 55 mm), typically a control compact system or active signal element.

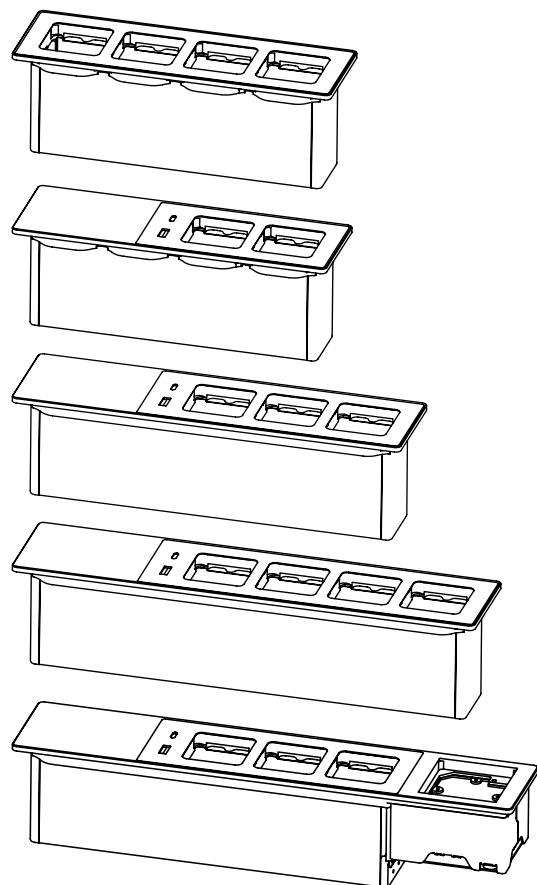

	DIMENSION	WEIGHT	MAX. NUMBER OF SOCKETS	MAX. NUMBER OF MODULES	POSSIBILITY OF Qi WIRELESS CHARGING	ADAPTER FOR CONTROL SYSTEM	DIMENSION WITH PULL-OUT CABLE SYSTEM
<b>BASIC</b>	227,5 × 73 × 81 mm	760 g	4	2	×	×	227,5 × 73 × 690 mm
<b>M</b>	227,5 × 73 × 81 mm	1150 g	2	1	✓	×	227,5 × 73 × 690 mm
<b>L</b>	279 × 73 × 81 mm	1260 g	3	2	✓	×	279 × 73 × 690 mm
<b>XL</b>	330,5 × 73 × 81 mm	1370 g	4	3	✓	×	330,5 × 73 × 690 mm
<b>PLUS</b>	360 × 73 × 81 mm	1740 g	3	2	✓	NEETS CUE	360 × 73 × 690 mm

# FLAT

by panconnect.

**BASIC**

## SOCKETS

NUMBER OF SOCKETS: 2-4

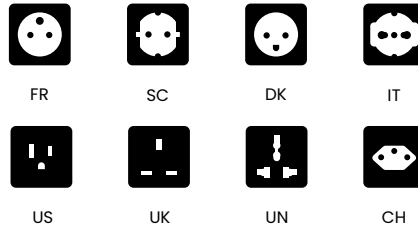

## MODULES

NUMBER OF MODULES: 0-2

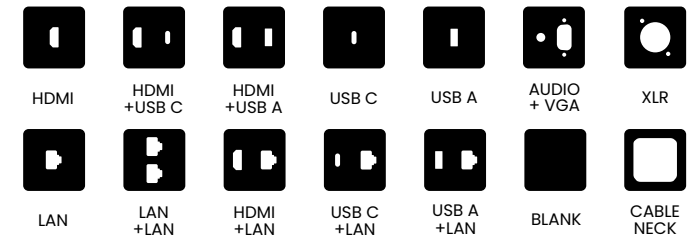

760 g

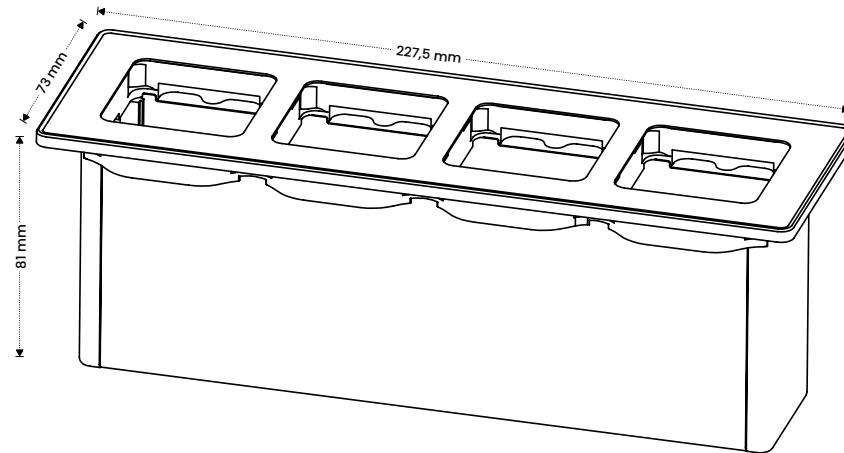

## COLOURS



black



white



silver

## POWER CABLES

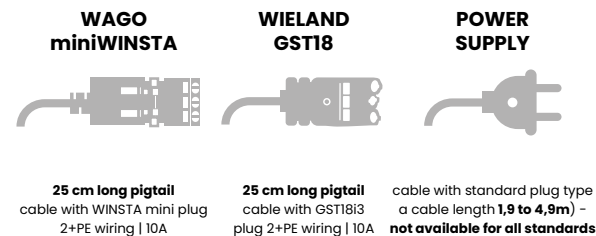

## PACKAGE CONTAINS

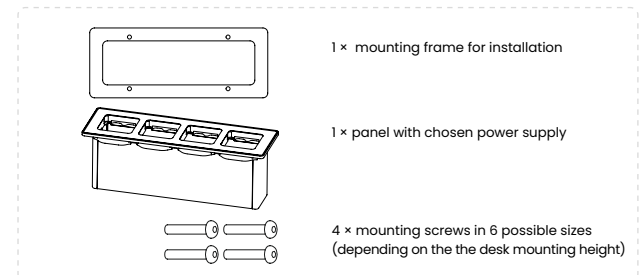

# FLAT

by panconnect•

**SIZE M**

## SOCKETS

NUMBER OF SOCKETS: 1-2

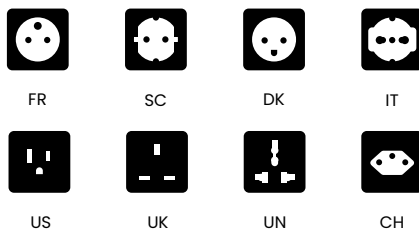

## MODULES

NUMBER OF MODULES: 0-1

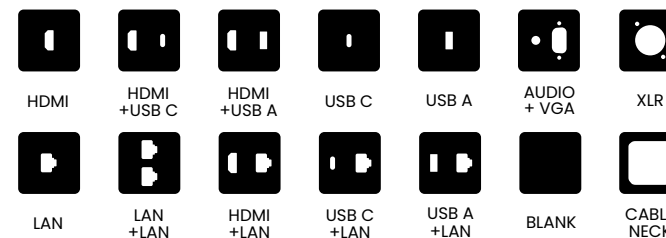

1150 g

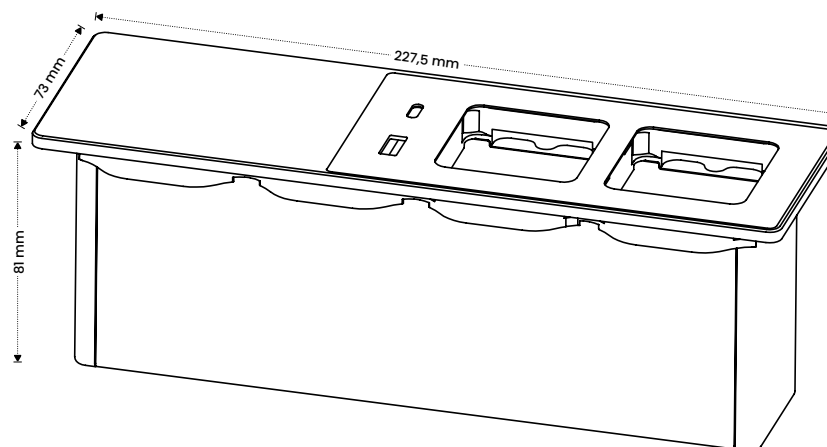

## COLOURS



black



white



silver

## WIRELESS CHARGING

Qi compliant 1.5A/5V

### WITH INTEGRATED Qi

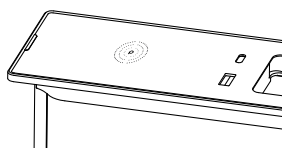

### WITHOUT INTEGRATED Qi

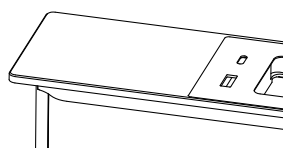

## POWER CABLES

### WAGO miniWINSTA



25 cm dlouhý pigtail  
kabel s WINSTA mini plug  
2+PE wiring | 10A

### WIELAND GST18



25 cm dlouhý pigtail  
kabel s GST18i3 plug  
2+PE wiring | 10A

### POWER SUPPLY



cable with standard plug type  
a cable length 1,9 to 4,9m) -  
**not available for all standards**

## PACKAGE CONTAINS

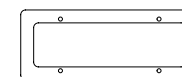

1 × mounting frame for installation

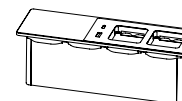

1 × panel with chosen power supply

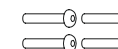

4 × mounting screws in 6 possible sizes  
(depending on the the desk mounting height)



# FLAT

by panconnect.

**SIZE L**

## SOCKETS

NUMBER OF SOCKETS: 1-3

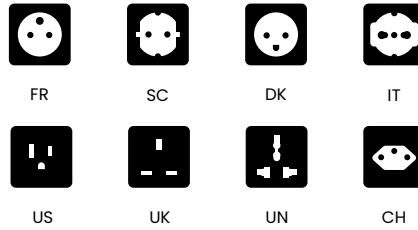

## MODULES

NUMBER OF MODULES: 0-2

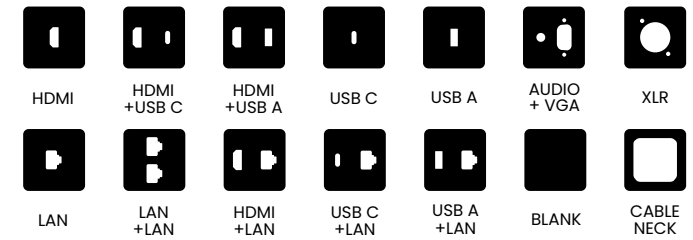

1260 g

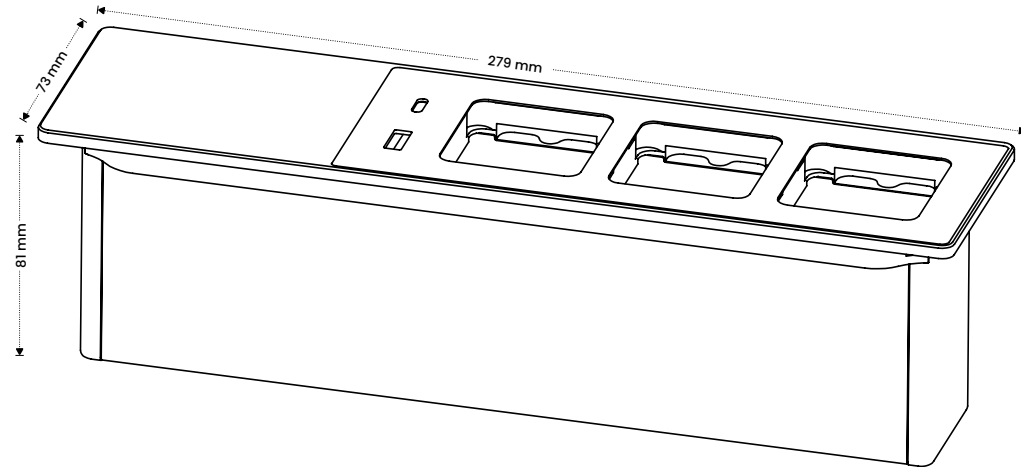

## COLOURS



black



white



silver

## WIRELESS CHARGING

Qi compliant 1.5A/5V

### WITH INTEGRATED Qi

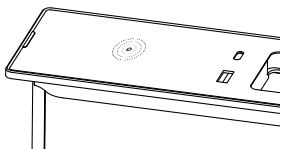

### WITHOUT INTEGRATED Qi

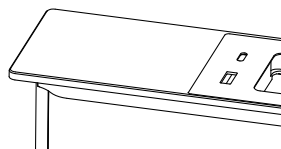

## POWER CABLES

### WAGO miniWINSTA



25 cm long pigtail  
cable with WINSTA mini plug  
2+PE wiring | 10A

### WIELAND GST18



25 cm long pigtail  
cable with GST18i3 plug  
2+PE wiring | 10A

### POWER SUPPLY



cable with standard plug type  
a cable length 1,9 to 4,9m) -  
**not available for all standards**

## PACKAGE CONTAINS

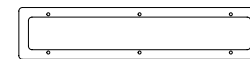

1 x mounting frame for installation

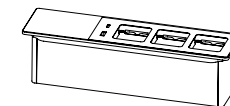

1 x panel with chosen power supply



6 x mounting screws in 6 possible sizes  
(depending on the desk mounting height)

# FLAT

by panconnect.

**SIZE XL**

## SOCKETS

NUMBER OF SOCKETS: 1-4

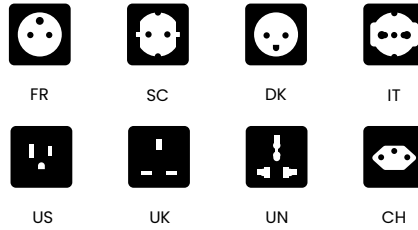

## MODULES

NUMBER OF MODULES: 0-3

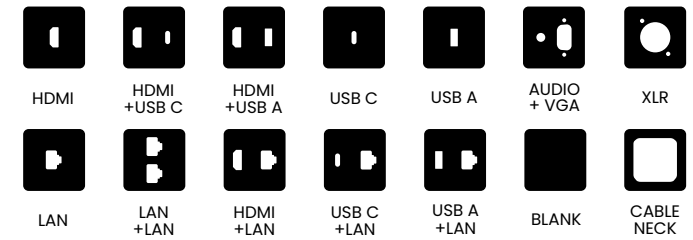

1370 g

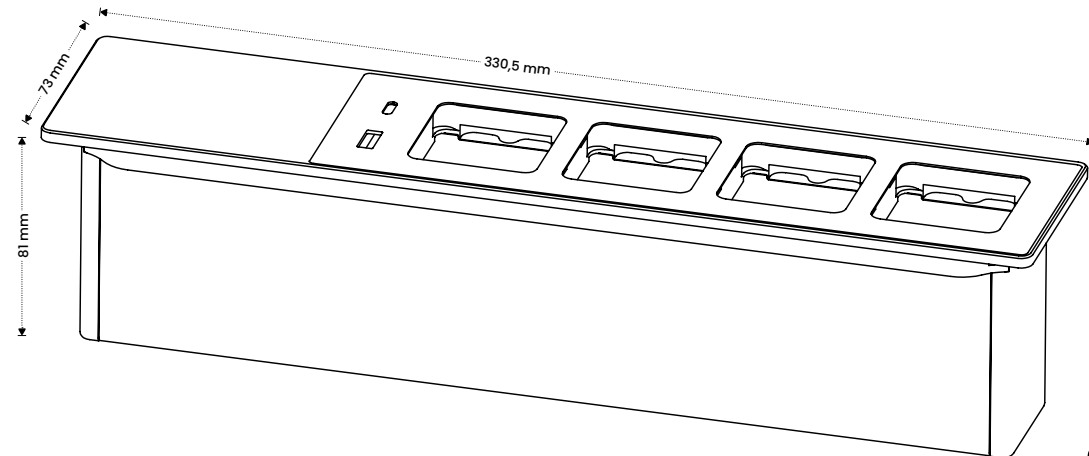

## COLOURS



black



white



silver

## WIRELESS CHARGING

Qi compliant 1.5A/5V

### WITH INTEGRATED Qi

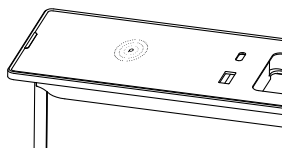

### WITHOUT INTEGRATED Qi

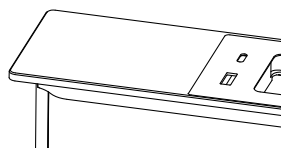

## POWER CABLES

### WAGO miniWINSTA



25 cm long pigtail  
cable with WINSTA mini plug  
2+PE wiring | 10A

### WIELAND GST18



25 cm long pigtail  
cable with GST18i3 plug  
2+PE wiring | 10A

### POWER SUPPLY



cable with standard plug type  
a cable length 1,9 to 4,9m) -  
**not available for all standards**

## PACKAGE CONTAINS

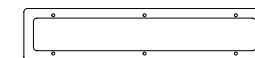

1 x mounting frame for installation

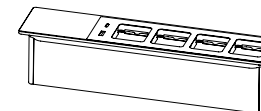

1 x panel with chosen power supply

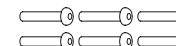

6 x mounting screws in 6 possible sizes  
(depending on the the desk mounting height)

# FLAT

by panconnect.

PLUS

## CONTROL SYSTEM

### NEETS



it is ready for easy installation of **standard 55 x 55 mm** control system from Blamp/Neets (BraVo, OsCar, Echo, Sierra)

### CUE



it is ready for installation of **small wired 8-button** keypad CUE-55 from CUE systems

### OWN INTEGRATION



other **control system up to 55 x 55 mm** size supported. For more information please contact your sales rep.

## COLOURS



black



white



silver

## WIRELESS CHARGING

Qi compliant 1.5A/5V

### WITH INTEGRATED Qi

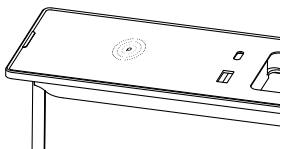

### WITHOUT INTEGRATED Qi

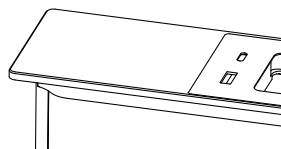

## SOCKETS

NUMBER OF SOCKETS: 1-3



FR



SC



DK



IT



US



UK



UN



CH

## MODULES

NUMBER OF MODULES: 0-2



HDMI



HDMI + USB C



HDMI + USB A



USB C



USB A



AUDIO + VGA



XLR



LAN



LAN + LAN



HDMI + LAN



USB C + LAN



USB A + LAN



BLANK



CABLE NECK



1740 g

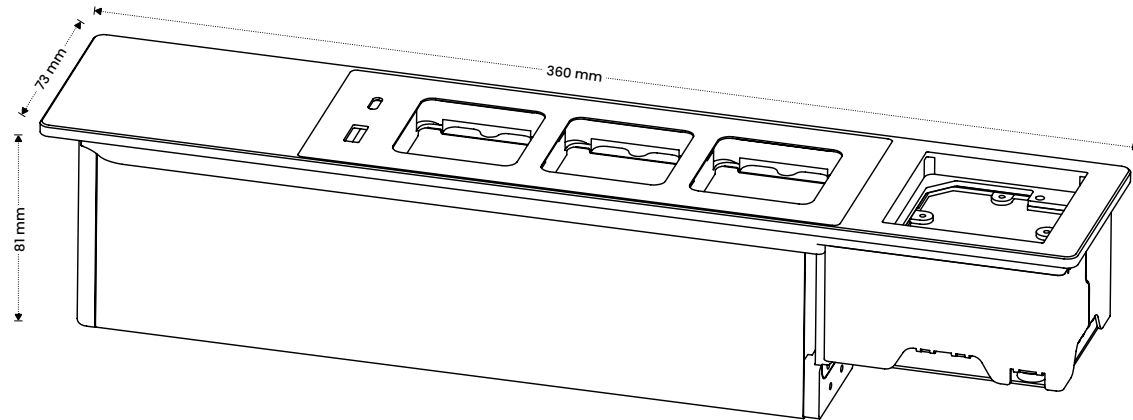

## POWER CABLES

### WAGO miniWINSTA



**25 cm LONG pigtail**  
cable with WINSTA mini plug  
2+PE wiring | 10A

### WIELAND GST18



**25 cm LONG pigtail**  
cable with GST18i3 plug  
2+PE wiring | 10A

### POWER CABLE



cable with standard plug type  
a cable length **1,9 to 4,9m** -  
**not available for all standards**

## PACKAGE CONTAINS

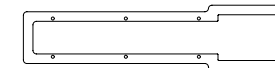

1 x mounting frame for installation

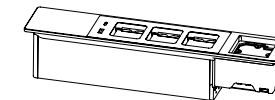

1 x panel with chosen power supply

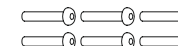

6 x mounting screws in 6 possible sizes  
(depending on the desk mounting height)

# MODULES

by panconnect.

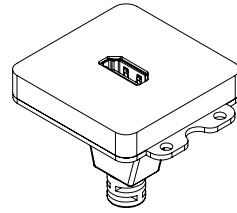

## HDMI HDM12.0b

F/F  
4K 60HZ  
150mm  
gold plated  
awg32/22  
black pvc

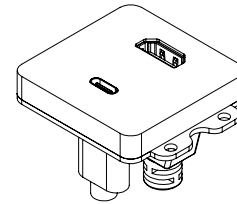

## USB-C 3.2 GEN 2

M/F  
10Gbps  
150mm  
gold and nickel plated  
black pvc

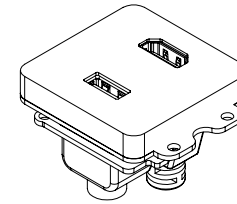

## USB-A 3.0 GEN 2

F/F  
5Gbps | 135mm  
gold and nickel plated  
AWG 28/28  
black pvc

## HDMI HDM12.0b

F/F | 4K 60HZ  
150mm | gold plated  
awg32/22  
black pvc

## HDMI HDM12.0b

F/F | 4K 60HZ  
150mm | gold plated  
awg32/22  
black pvc

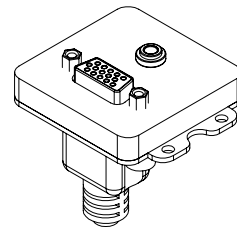

## VGA DDC2 and EDID support

F/F  
HD  
150mm  
15pin  
black pvc

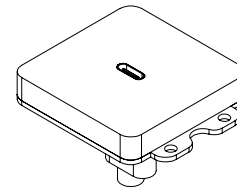

## USB-C 3.2 GEN 2

M/F  
10Gbps  
150mm  
gold and nickel plated  
black pvc

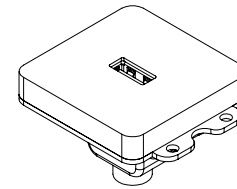

## USB-A 3.0 GEN 2

F/F  
5Gbps | 135mm  
gold and nickel plated  
AWG 28/28  
black pvc

## AUDIO

F/F | 3,5mm jack  
3 PIN 0,35mm  
150mm  
goldplated  
black pvc

## COLOURS



black



white



silver

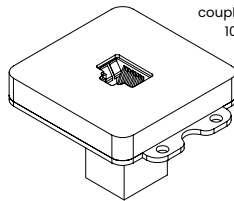

## LAN CAT 6A

coupler RJ45 | up to 500MHz,  
10GBase-T | Gold-plated  
360° shielded  
connection  
Fully shielded  
metal housing

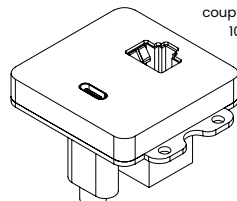

## LAN CAT 6A

coupler RJ45 | up to 500MHz,  
10GBase-T | Gold-plated  
360° shielded  
connection  
Fully shielded  
metal housing

## USB-C 3.2 GEN 2

M/F  
10Gbps | 150mm  
gold and nickel plated  
black pvc

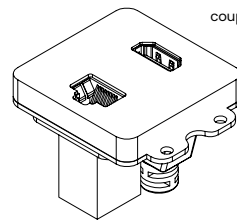

## LAN CAT 6A

coupler RJ45 | up to 500MHz,  
10GBase-T | Gold-plated  
360° shielded  
connection  
Fully shielded  
metal housing

## HDMI HDM12.0b

F/F | 4K 60HZ  
150mm | gold plated  
awg32/22  
black pvc

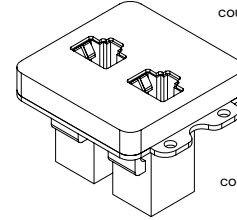

## LAN CAT 6A

coupler RJ45 | up to 500MHz,  
10GBase-T | Gold-plated  
360° shielded  
connection  
Fully shielded  
metal housing

## LAN CAT 6A

coupler RJ45 | up to 500MHz,  
10GBase-T | Gold-plated  
360° shielded  
connection | Fully shielded | metal housing

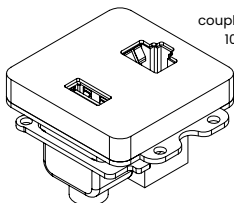

## LAN CAT 6A

coupler RJ45 | up to 500MHz,  
10GBase-T | Gold-plated  
360° shielded  
connection  
Fully shielded  
metal housing

## USB-A 3.0 GEN 2

F/F  
5Gbps | 135mm  
gold and nickel plated  
AWG 28/28 | black pvc

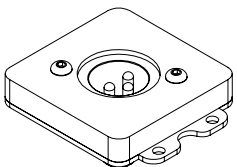

## XLR

XLR socket FEMALE  
16 A  
direct 3pin solder-on  
25mm  
nickled  
Black PLA

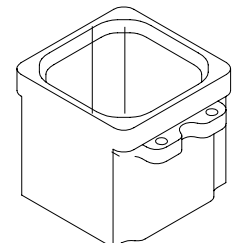

## CABLE NECK

pull-out  
connector  
modul

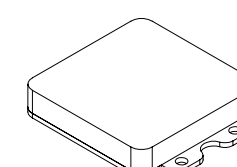

## BLANK

PRAZDNÁ POZICE  
PRO PŘÍPADNÉ  
POZDĚJŠÍ POUŽITÍ

# PULL-OUT SYSTEM

by panconnect•

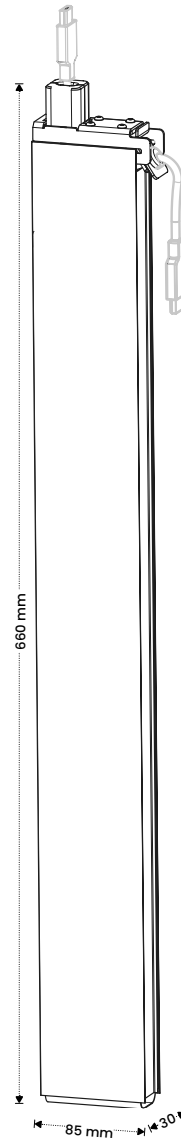

**PULL-OUT** - mechanism that works on the principle of gravity weighted cables in a textile bag and it allows the cable to be pulled up to 96 cm (the total length of the cable is 200 cm).

## WEIGHT

SIZE S

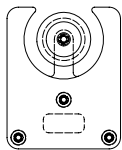

260 g

SIZE M

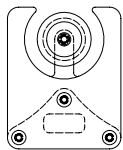

360 g

SIZE L

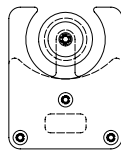

460 g

## PACKAGE CONTAINS:



1 x pull-out system

## CABLES

NUMBER OF CABLES:

1-2

### USB-C 3.2 (M-M)

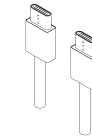

USB-C 3.2 gen 1  
5Gbps | 200cm  
gold and nickel plated  
black pvc

### USB-C 3.2 (M-F)

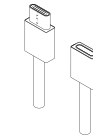

USB-C 3.2 gen 1  
5Gbps | 200cm  
gold and nickel plated  
black pvc

### USB-C (M) / HDMI (M)

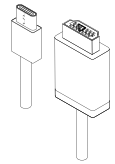

HDMI2.0 | 4K60Hz  
200cm  
gold-plated  
AWG32 / 22 | black pvc

### mini DISPLAY PORT (M) / HDMI (M)

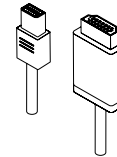

DP | 4K30Hz  
200cm  
4K/UHD/2160p@60Hz  
black pvc

### DISPLAY PORT (M-M)

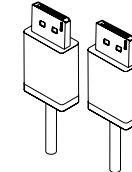

DPI.4 | 8K60Hz  
200cm  
gold-plated  
AWG32 / 22 | black pvc

### DISPLAY PORT (M) / HDMI (M)

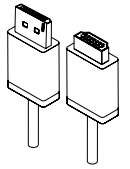

2K DP | WUXGA (1920x1200)  
200cm  
SECURE LOCK | gold-plated  
AWG28 | black pvc

### HDMI (M-M)

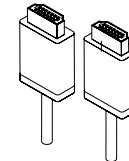

HDMI1.4 | 4K30Hz  
200cm  
gold-plated | AWG32 / 22  
black pvc

### HDMI (M-F)

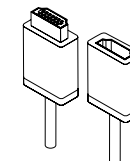

HDMI1.4 | 4K30Hz  
200cm  
gold-plated | AWG32 / 22  
black pvc

### USB 3.0 (M-F)

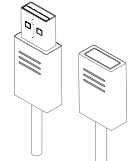

USB3.0 | 5Gbps  
200cm  
9pin  
AWG28/28 | black pvc

### LAN (M-M)

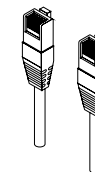

CAT6 RJ45 | UTP  
200cm  
CU 4x2  
AWG26/7 | black pvc



# SAFETY & RECYCLATION



PANCONNECT declares that panel **FLAT** complies with Low voltage directive 2014/35/EC and EMC directive 2014/30/EU. Testing has been made according to EN 50491-5-1:2010 and EN 50491-5-2:2010 standards.



All products from **PANCONNECT** are intended for **upgrade** or **recyclation** in accordance with the company's policy.



Before the disposal of this panel comes up, please verify if this product can or cannot be upgraded or overhauled. If it's not possible, kindly arrange the disposal in accordance with valid EU directives. This product belongs to WASTE ELECTRICAL AND ELECTRONIC EQUIPMENT (WEEE) category so the disposal is possible only in accordance with this WEEE Directive 2012/19/EU. It cannot be part of the municipal waste.

**For more information please check**  
[www.asekol.cz](http://www.asekol.cz) | [info@asekol.cz](mailto:info@asekol.cz)

## INSTALLATION MANUAL



### Easy installation

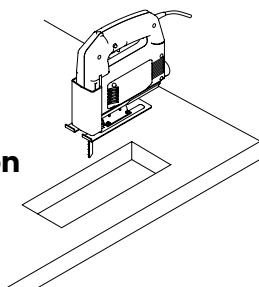

**DESK MOUNTING HEIGHT**  
10 mm  
to 40 mm  
(up to 60mm with custom screws)

**Tools: jig saw, drill and bit Ø 10mm**

- 01** Mark 4 holes according to the cutout and drill them with the bit
- 02** Take a jig saw and cut the holes
- 03** Put the panel to the hole and place the metal frame over the bottom part of the panel and tighten the screws
- 04** If you've chosen pull-out system for your panel, add it now

### USB-C SPECIFICATION

PowerDelivery up to 60W

### USB-A SPECIFICATION

QuickCharge 3.0 up to 5A

### SOCKETS

230V/10A (EU), 110V/10A (US)

### INGRESS PROTECTION

IP22

### POWER SUPPLY

110 - 250V, 10A

### MODULARITY

MODULES | PASS-THRU | PULL-OUT

### MATERIALS

Dural | stainless steel | FENIX NTM | cortexin

### DESIGNER

Dominik Hutečka

**Designed & manufactured in Brno, Czech Republic.**  
PANCONNECT s.r.o. | Olomoucká 51, Brno | Czech Republic  
[www.panconnect.eu](http://www.panconnect.eu) | [support@panconnect.eu](mailto:support@panconnect.eu)

**panconnect**