

# EDGE

by panconnect•

**EDGE** je ergonomický kovový panel, který se instaluje jednoduše na hranu stolu, a to bez vrtání. K dostání je v bílé nebo černé barvě ve 3 různých velikostech. Součástí panelu je vždy zásuvka a poté volitelně USB nabíjení nebo konektory.

**EDGE XS** je nejmenší variantou, která se vyrábí se zásuvkou a USB nabíjením, případně se 2 zásuvkami.

**EDGE S** obsahuje alespoň jednu zásuvku a dále variantně konektor, USB nabíjení nebo další zásuvky.

**EDGE M** obsahuje v základu vždy 2 zásuvky a variantně pak USB nabíjení, konektory nebo další zásuvky. Na míru školícím místnostem jsme vyrobili variantu se 2 zásuvkami a 2 USB nabíjenými, kde 1 panel pokryje nabíjení pro 2 uživatele.

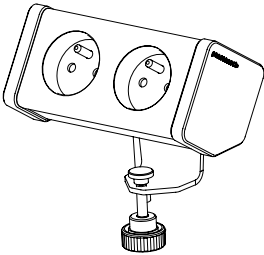
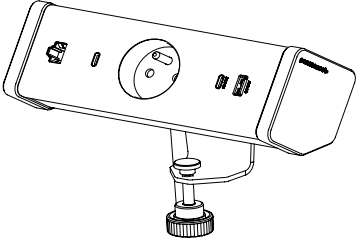
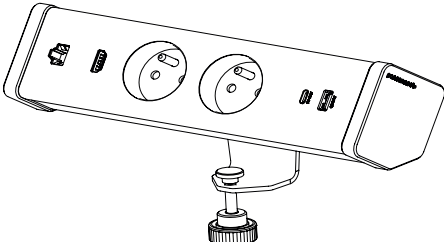
	ROZMĚR PANELU	VÁHA PANELU	MAX. POČET ZÁSUVEK	KONEKTOROVÉ POLE	USB-C+USB-A NABÍJENÍ
 <b>XS</b>	130 × 90 × 72 mm	980 g	2	až 1	✓
 <b>S</b>	180 × 90 × 72 mm	1100 g	3	až 2	✓
 <b>M</b>	230 × 90 × 72 mm	1220 g	3	až 2	✓

# EDGE

by panconnect•

SIZE XS

## BAREVNOST



Black



White

## ZÁSUVKY

POČET ZÁSUVEK K POUŽITÍ: 1-2



FR



SC



DK



IT



US



UK



UN



CH



980 g

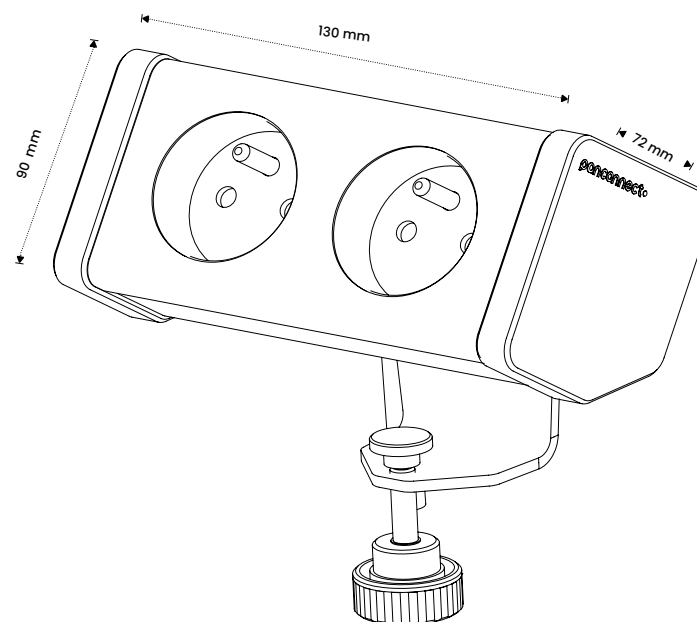

## VARIANTY PANELU

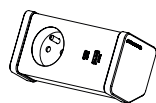

1 × zásuvka  
USB-C/A

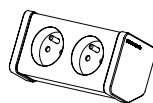

2 × zásuvka

## ZDROJOVÝ KABEL

### KABEL SE ZÁSTRČKOU

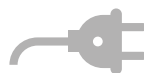

kabel se standardním typem zástrčky a délkou **1,9-4,9 m** není dostupný pro všechny světové standardy

### WAGO miniWINSTA



**25 cm dlouhý pigtail**  
kabel s WINSTA mini plug  
2+PE wiring | 10A

### WIELAND GST18



**25 cm dlouhý pigtail**  
kabel s GST18i3 plug  
2+PE wiring | 10A

## CO NALEZNETE V BALENÍ ?

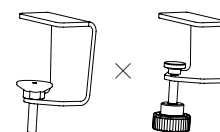

1 × vybrané uchycení ke stolu

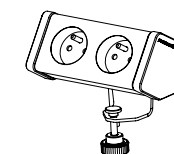

1 × panel s vybraným zdrojovým kabelem

# EDGE

by panconnect•

SIZE S

## BAREVNOST



Black



White

## ZÁSUVKY

POČET ZÁSUVEK K POUŽITÍ: 1-3



FR



SC



DK



IT



US



UK



UN



CH



1100 g

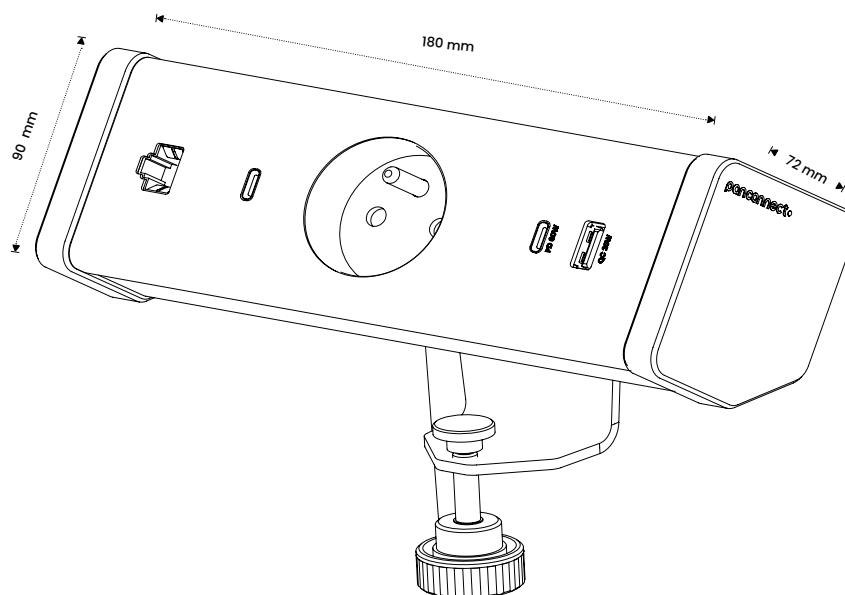

## KONEKTOROVÁ POLE

K POUŽITÍ:

0-1



HDMI



USB C



LAN



USB A  
+LAN



LAN  
+LAN



HDMI  
+LAN



USB C  
+LAN

## ZDROJOVÝ KABEL

KABEL SE  
ZÁSTRČKOU

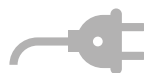

kabel se standardním typem  
zástrčky a délkou **1,9-4,9 m**  
*není dostupný pro všechny  
světové standardy*

WAGO  
miniWINSTA



**25 cm dlouhý pigtail**  
kabel s WINSTA mini plug  
2+PE wiring | 10A

WIELAND  
GST18



**25 cm dlouhý pigtail**  
kabel s GST18 plug  
2+PE wiring | 10A

## CO NALEZNETE V BALENÍ ?

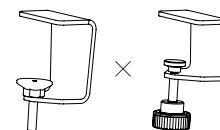

1 × vybrané uchycení  
ke stolu

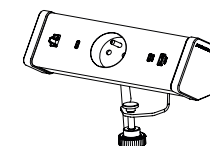

1 × panel s vybraným  
zdrojovým kabelem

# EDGE

by panconnect•

**SIZE S**

VARIANTY PANELU

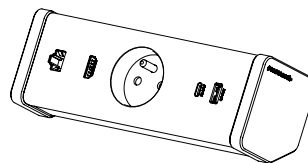

1x 230V, USB C/A  
HDMI, LAN Cat6A

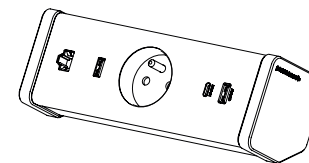

1x 230V, USB C/A  
USB-A, LAN Cat6A

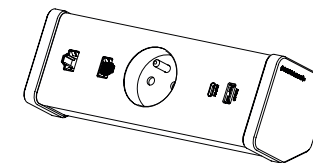

1x 230V, USB C/A  
2x LAN Cat6A

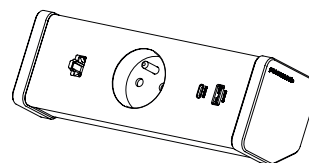

1x 230V, USB C/A  
LAN Cat6A

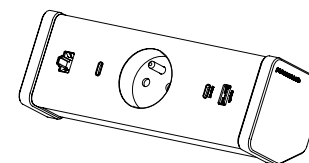

1x 230V, USB C/A  
USB-C, LAN Cat6A

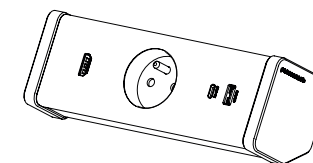

1x 230V, USB C/A  
HDMI

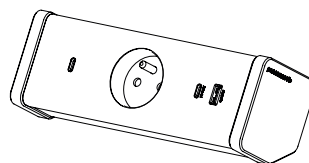

1x 230V, USB C/A  
USB-C

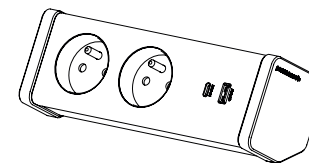

2x 230V, USB C/A  
-

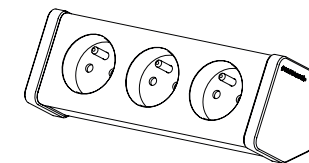

3x 230V  
-

# EDGE

by panconnect•

SIZE M

VARIANTY PANELU

KONEKTOROVÁ POLE

K POUŽITÍ:

0-1



HDMI



USB C



LAN



USB A  
+LAN



LAN  
+LAN



HDMI  
+LAN



USB C  
+LAN

BAREVNOST



Black



White

ZÁSUVKY

POČET ZÁSUVEK K POUŽITÍ: 2-3



FR



SC



DK



IT



US



UK



UN



CH



1220 g

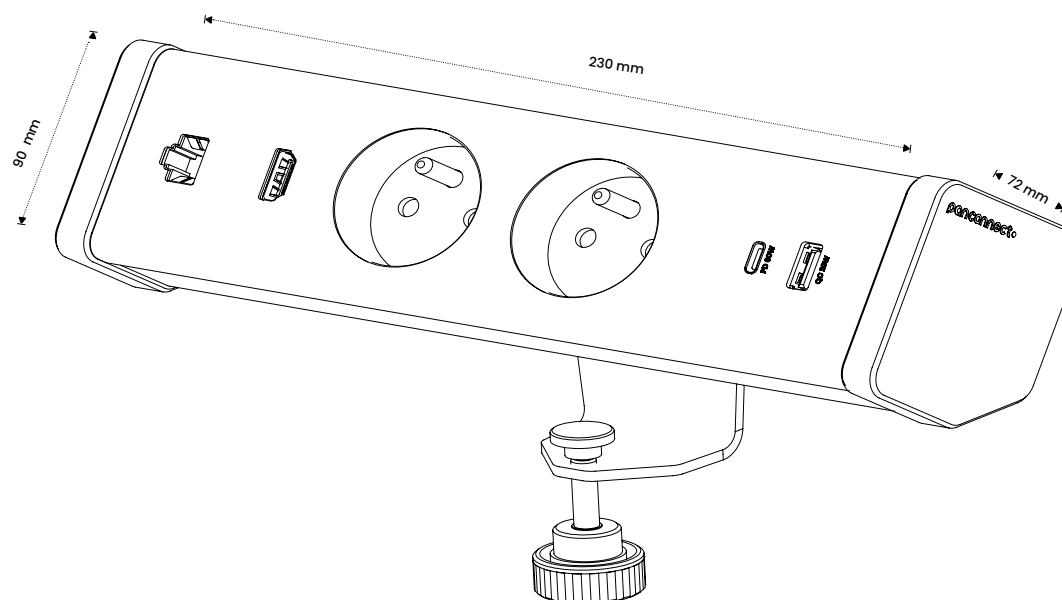

ZDROJOVÝ KABEL

KABEL SE  
ZÁSTRČKOU

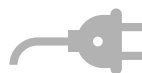

kabel se standardním typem  
zástrčky a délkou **1,9-4,9 m**  
není dostupný pro všechny  
světové standardy

WAGO  
miniWINSTA



**25 cm dlouhý pigtail**  
kabel s WINSTA mini plug  
2+PE wiring | 10A

WIELAND  
GST18



**25 cm dlouhý pigtail**  
kabel s GST18i3 plug  
2+PE wiring | 10A

CO NALEZNETE V BALENÍ ?

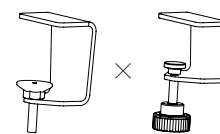

1 × vybrané uchycení  
ke stolu

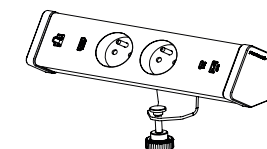

1 × panel s vybraným  
zdrojovým kabelem

BASICS

EDGE by panconnect | 05

# EDGE

by panconnect•

**SIZE M**

VARIANTY PANELU

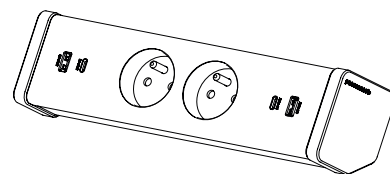

2x 230V, 2x USB C/A

-

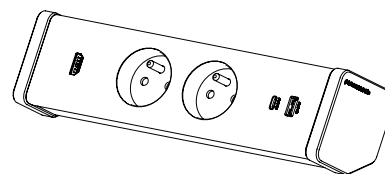

2x 230V, USB C/A

HDMI

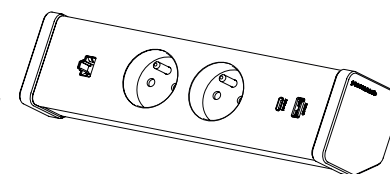

2x 230V, USB C/A

LAN Cat6A

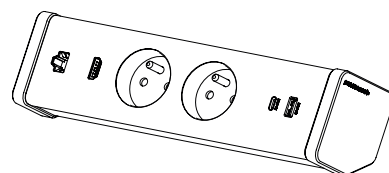

2x 230V, USB C/A

LAN Cat6A, HDMI

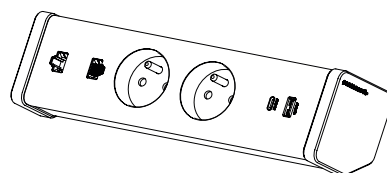

2x 230V, USB C/A

2x LAN Cat6A

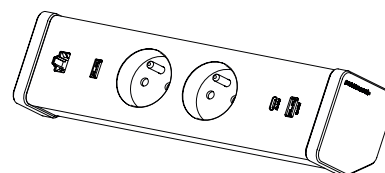

2x 230V, USB C/A

LAN Cat6A, USB-A

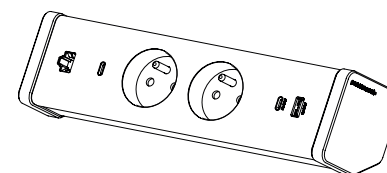

2x 230V, USB C/A

LAN Cat6A, USB-C

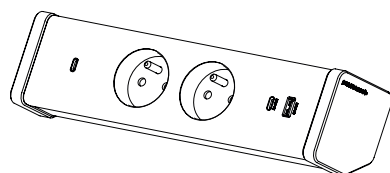

2x 230V, 2x USB C/A

USB-C

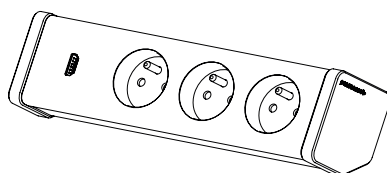

3x 230V,

HDMI

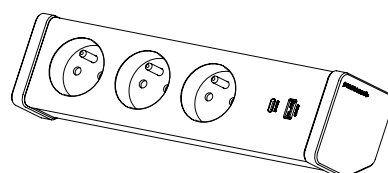

3x 230V, USB C/A

-

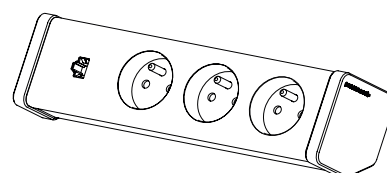

3x 230V,

LAN Cat6A

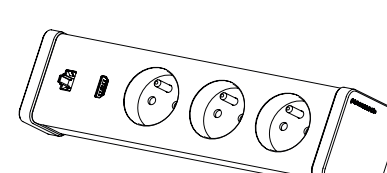

3x 230V,

LAN Cat6A, HDMI

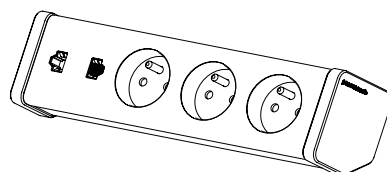

3x 230V,

2x LAN Cat6a

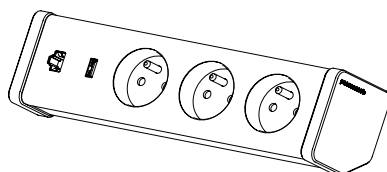

3x 230V,

LAN Cat6a, USB-A

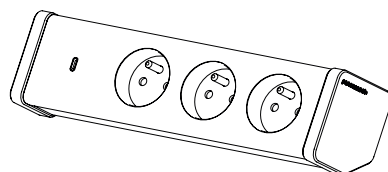

3x 230V,

USB-C

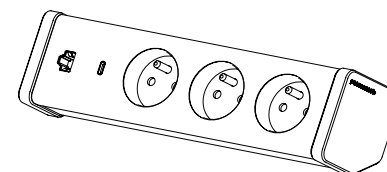

3x 230V,

LAN Cat6a, USB-C

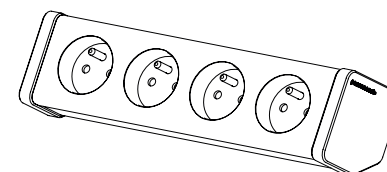

4x 230V,

-

B A S I C S

# BEZPEČNOST & RECYKLACE



PANCONNECT tímto prohlašuje, že přípojný panel EDGE vyhovuje směrnici o nízkém napětí (2014/35/EU) a také směrnici o Elektromagnetické kompatibilitě (2014/30 EU). Testování bylo provedeno dle norem EN 50491-5-1:2010, EN 50491-5-2:2010.



Produkty PANCONNECT jsou v souladu s politikou společnosti určeny k **upgradu**, nejlépe pak maximální **recyklaci**.



Než přistoupíte k likvidaci, ověřte si u nás, zda-li je možné produkt upgradovat nebo repasovat. Pokud to není možné zajistěte jeho likvidaci dle platných směrnic. Produkt spadá do skupiny ODPAD Z ELEKTRONICKÝCH ZAŘÍZENÍ, jeho likvidace je možná pouze v souladu s evropskou směrnicí 2012/19/EU a nelze jej likvidovat společně s komunálním odpadem. [www.asekol.cz](http://www.asekol.cz) | [info@asekol.cz](mailto:info@asekol.cz)

## INSTRUKCE K INSTALACI



### Jednoduchá instalace

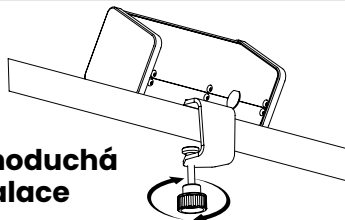

**2 TYPY UPNUTÍ  
DLE VÝŠKY  
STOLU**  
**UPNUTÍ A**  
10–25 mm  
**UPNUTÍ B**  
25–45 mm

**Potřebujete:** Nainstalováno za pár minut! Pro instalaci tohoto panelu nepotřebujete žádné nářadí. Je třeba si vybrat velikost zadního upnutí

(10–30 mm nebo 30–45mm).

- 01** Nasadte panel nadoraz na desku stolu
- 02** Dle zvoleného úchyty připevněte panel ke stolu
- 03** Přidělejte držák ke stolu a dotejte panel

B A S I C S

### USB-C SPECIFIKACE

PowerDelivery up to 60W

### USB-A SPECIFIKACE

QuickCharge 3.0 up to 5A

### SPECIFIKACE ZÁSUVK

230V/10A (EU), 110V/10A (US)

### OCHRANA PROTI VNIKNUTÍ

IP22

### ELEKTRICKÉ SPECIFIKACE VSTUPNÍ

110 – 250V, 10A

### MODULARITA

KONEKTOROVÉ POLE

### MATERIÁLY

Aluminium | ABS | Carbon steel

### DESIGNER

Dominik Hutečka

Designed & manufactured in Brno, Czech Republic.  
PANCONNECT s.r.o. | Olomoucká 51, Brno | Czech Republic  
[www.panconnect.eu](http://www.panconnect.eu) | [support@panconnect.eu](mailto:support@panconnect.eu)

panconnect