

FLAT

by panconnect

FLAT je základní, ale přitom velmi univerzální panel pro použití na pracovních místech, jednacích stolech, konferenčních místnostech i kdekoliv, kde je potřeba univerzální konektivita. Nabízí celkem **5 provedení** a přitom stále zachovává požadavek na maximální modularitu, nízkou instalační hloubku a jednoduchou instalaci.

Základní **FLAT LITE** obsahuje pouze zásuvky a konektorové moduly, případně modul pro vytahovací kabel (modul pro PULL-OUT nebo PASS-THRU). **FLAT M, L a XL** jsou pak tři

velikosti podle požadavku konektivity a počtu zásuvek. Všechny obsahují nabíjecí **USB-A** a **USB-C** (60W) sloty a variantně také Qi nabíjení integrované přímo v panelu.

FLAT PLUS je doplněn o rozšířenou část pro osazení 45mm až 55mm aktivního modulu třetí strany, typicky řídicího systému.

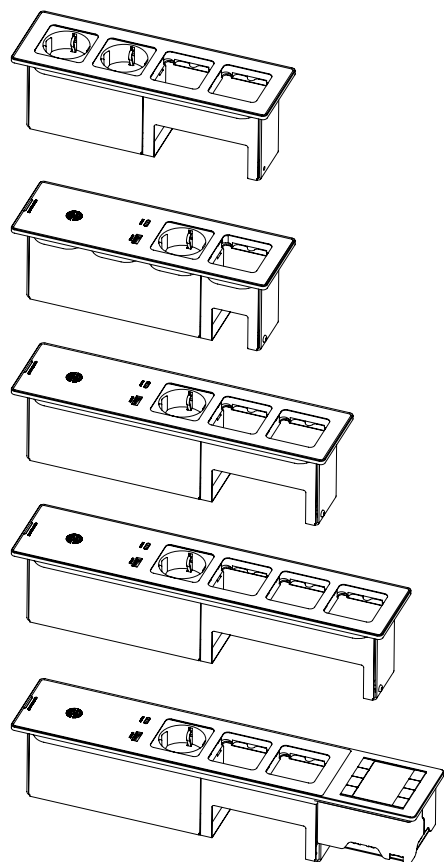

	ROZMĚR PANELU	VÁHA PANELU	MAX. POČET ZÁSUVEK	MAX. POČET MODULKŮ	MOŽNOST QI BEZDRÁTOVÉ NABÍJENÍ	ADAPTÉR PRO ŘÍDÍCÍ SYSTÉM	ROZMĚR PANELU S KABELOVÝM SYSTÉMEM PULL-OUT
LITE	227,5 × 73 × 81 mm	760 g	4	2	×	×	227,5 × 73 × 690 mm
M	227,5 × 73 × 81 mm	1150 g	2	1	✓	×	227,5 × 73 × 690 mm
L	279 × 73 × 81 mm	1260 g	3	2	✓	×	279 × 73 × 690 mm
XL	330,5 × 73 × 81 mm	1370 g	4	3	✓	×	330,5 × 73 × 690 mm
PLUS	360 × 73 × 81 mm	1740 g	2	2	✓	NEETS CUE	360 × 73 × 690 mm

FLAT

by panconnect

LITE

ZÁSUVKY

POČET ZÁSUVEK K POUŽITÍ: 2-4

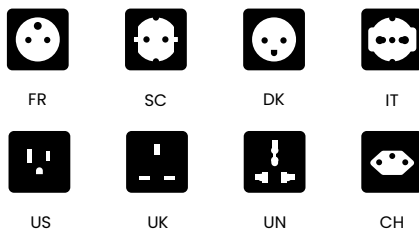

MODULKY

POČET MODULKŮ K POUŽITÍ: 0-2

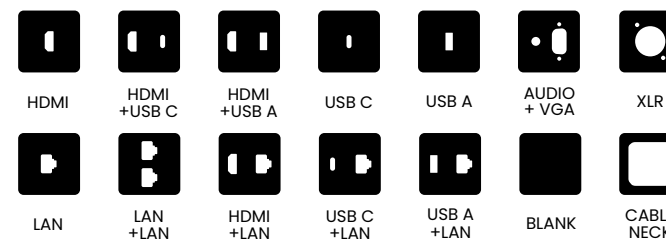

760 g

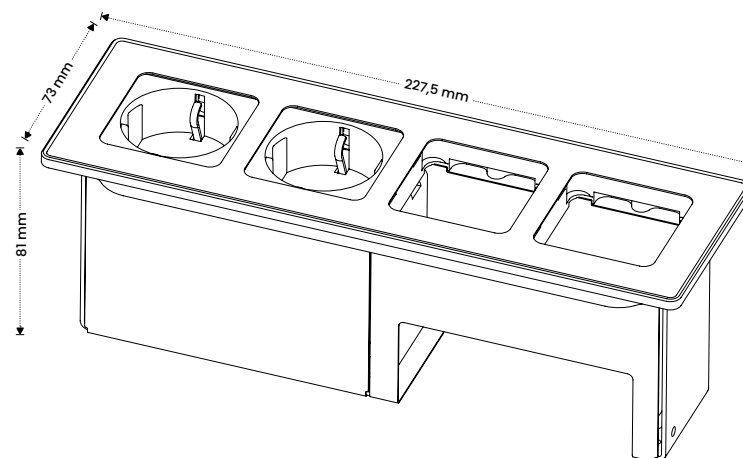

BAREVNOST



Onyx Black



Cotton White



Alu Silver

ZDROJOVÝ KABEL

KABEL SE ZÁSTRČKOU

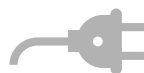

kabel se standardním typem zástrčky a délkou **1,9-4,9 m** není dostupný pro všechny světové standardy

WAGO miniWINSTA



25 cm dlouhý pigtail
kabel s WINSTA mini plug
2+PE wiring | 10A

WIELAND GST18



25 cm dlouhý pigtail
kabel s GST18i3 plug
2+PE wiring | 10A

CO NALEZNETE V BALENÍ ?

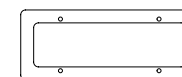

1 × montážní rámeček pro instalaci

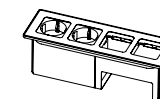

1 × panel s vybraným zdrojovým kabelem

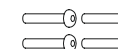

4 × montážní šroub v 6 možných velikostech (v závislosti na montážní výšce stolu)

MODULAR

FLAT

by panconnect

SIZE M

BAREVNOST



Onyx Black



Cotton White



Alu Silver

BEZDRÁTOVÉ DOBÍJENÍ

Qi compliant 1.5A/5V

S INTEGROVANÝM QI

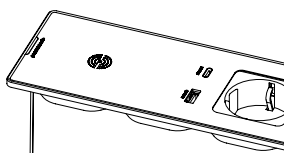

BEZ INTEGROVANÉHO QI

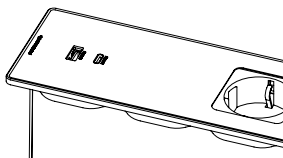

MODULAR

ZÁSUVKY

POČET ZÁSUVEK K POUŽITÍ: 1-2



FR



SC



DK



IT



US



UK



UN



CH

MODULKY

POČET MODULKŮ K POUŽITÍ: 0-1



HDMI



HDMI + USB C



HDMI + USB A



USB C



USB A



AUDIO + VGA



XLR



LAN



LAN + LAN



HDMI + LAN



USB C + LAN



USB A + LAN



BLANK



CABLE NECK



1150 g

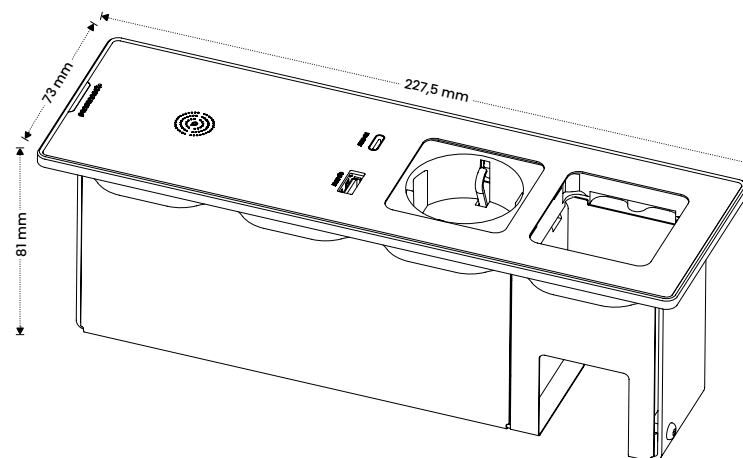

ZDROJOVÝ KABEL

KABEL SE ZÁSTRČKOU

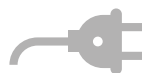

kabel se standardním typem zástrčky a délkou **1,9-4,9 m** není dostupný pro všechny světové standardy

WAGO miniWINSTA



25 cm dlouhý pigtail
kabel s WINSTA mini plug
2+PE wiring | 10A

WIELAND GST18



25 cm dlouhý pigtail
kabel s GST18i3 plug
2+PE wiring | 10A

CO NALEZNETE V BALENÍ ?

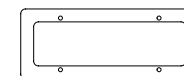

1 × montážní rámeček pro instalaci

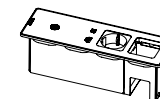

1 × panel s vybraným zdrojovým kabelem



4 × montážní šroub v 6 možných velikostech (v závislosti na montážní výšce stolu)

FLAT

by panconnect

SIZE L

BAREVNOST



Onyx Black



Cotton White



Alu Silver

BEZDRÁTOVÉ DOBÍJENÍ

Qi compliant 1.5A/5V

S INTEGROVANÝM QI

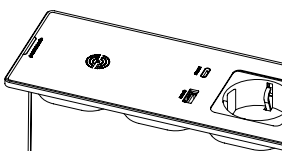

BEZ INTEGROVANÉHO QI

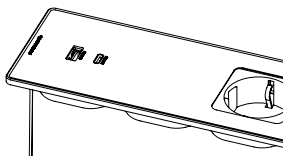

MODULAR

ZÁSUVKY

POČET ZÁSUVEK K POUŽITÍ: 1-3



FR



SC



DK



IT



US



UK



UN



CH

MODULKY

POČET MODULKŮ K POUŽITÍ: 1-2



HDMI



HDMI + USB C



HDMI + USB A



USB C



USB A



AUDIO + VGA



XLR



LAN



LAN + LAN



HDMI + LAN



USB C + LAN



USB A + LAN



BLANK



CABLE NECK



1260 g

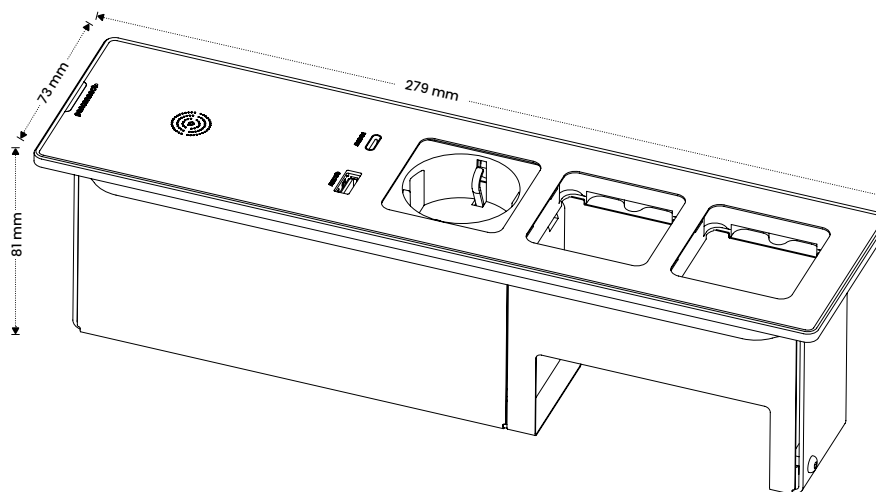

ZDROJOVÝ KABEL

KABEL SE ZÁSTRČKOU



kabel se standardním typem zástrčky a délkou 1,9-4,9 m není dostupný pro všechny světové standardy

WAGO miniWINSTA



25 cm dlouhý pigtail kabel s WINSTA mini plug 2+PE wiring | 10A

WIELAND GST18



25 cm dlouhý pigtail kabel s GST18i3 plug 2+PE wiring | 10A

CO NALEZNETE V BALENÍ ?

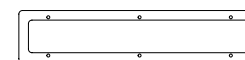

1 x montážní rámeček pro instalaci

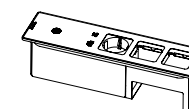

1 x panel s vybraným zdrojovým kabelem

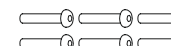

6 x montážní šroub v 6 možných velikostech (v závislosti na montážní výšce stolu)

FLAT

by panconnect

SIZE XL

BAREVNOST



Onyx Black



Cotton White



Alu Silver

BEZDRÁTOVÉ DOBÍJENÍ

Qi compliant 1.5A/5V

S INTEGROVANÝM QI

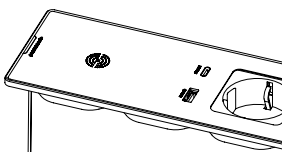

BEZ INTEGROVANÉHO QI

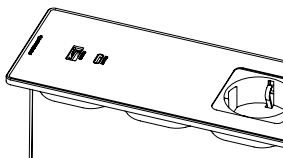

MODULAR

ZÁSUVKY

POČET ZÁSUVEK K POUŽITÍ: 1-4



FR



SC



DK



IT



US



UK



UN



CH

MODULKY

POČET MODULKŮ K POUŽITÍ: 1-3



HDMI



HDMI + USB C



HDMI + USB A



USB C



USB A



AUDIO + VGA



XLR



LAN



LAN + LAN



HDMI + LAN



USB C + LAN



USB A + LAN



BLANK



CABLE NECK



1370 g

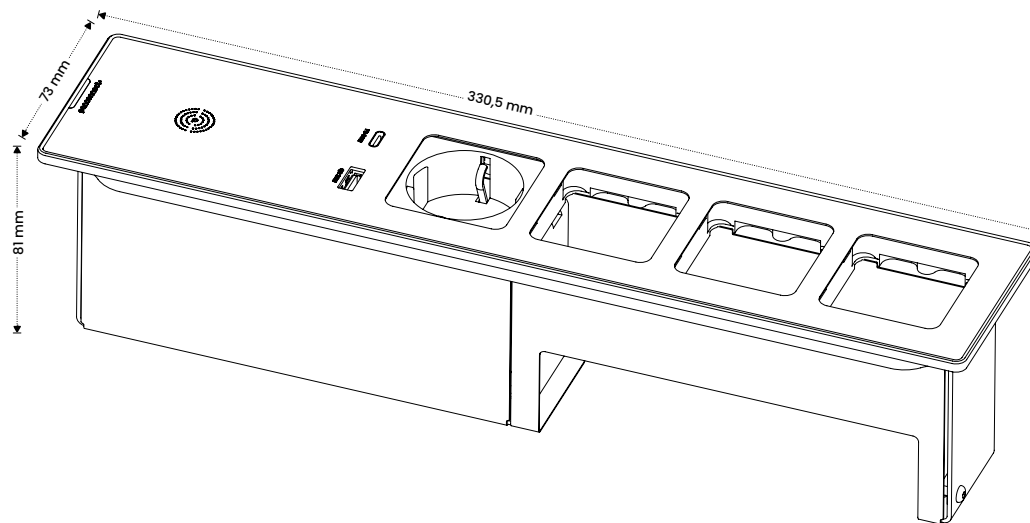

ZDROJOVÝ KABEL

KABEL SE ZÁSTRČKOU



kabel se standardním typem zástrčky a délkou 1,9-4,9 m není dostupný pro všechny světové standardy

WAGO miniWINSTA



25 cm dlouhý pigtail kabel s WINSTA mini plug 2+PE wiring | 10A

WIELAND GST18



25 cm dlouhý pigtail kabel s GST18i3 plug 2+PE wiring | 10A

CO NALEZNETE V BALENÍ ?

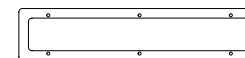

1 x montážní rámeček pro instalaci

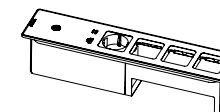

1 x panel s vybraným zdrojovým kabelem

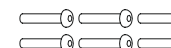

6 x montážní šroub v 6 možných velikostech (v závislosti na montážní výšce stolu)

FLAT

by panconnect

PLUS

ŘÍDÍCÍ SYSTÉM

BIAMP NEETS

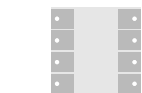

Připraveno pro snadnou instalaci standardního ovládacího panelu **55 x 55** systémů od Biamp/Neets (BraVo, OsCar, Echo, Sierra).

CUE



Připraveno k instalaci malé drátové 8-tlačítkové klávesnice CUE-55 od CUE systémů.

VLASTNÍ INTEGRACE



Podpora jiných řídicích systémů do velikosti **55 x 55 mm**. Pro více podrobností prosím kontaktujte vašeho prodejce.

BAREVNOST



Onyx Black



Cotton White



Alu Silver

BEZDRÁTOVÉ DOBÍJENÍ

Qi compliant 1.5A/5V

S INTEGROVANÝM QI

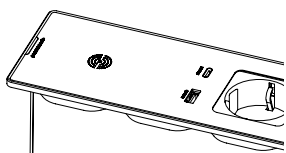

BEZ INTEGROVANÉHO QI

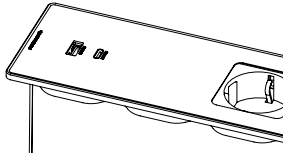

ZÁSUVKY

POČET ZÁSUVEK K POUŽITÍ: 1-2



FR



SC



DK



IT



US



UK



UN



CH

MODULKY

POČET MODULKŮ K POUŽITÍ: 1-2



HDMI



HDMI +USB C



HDMI +USB A



USB C



USB A



AUDIO + VGA



XLR



LAN



LAN +LAN



HDMI +LAN



USB C +LAN



USB A +LAN



BLANK



CABLE NECK

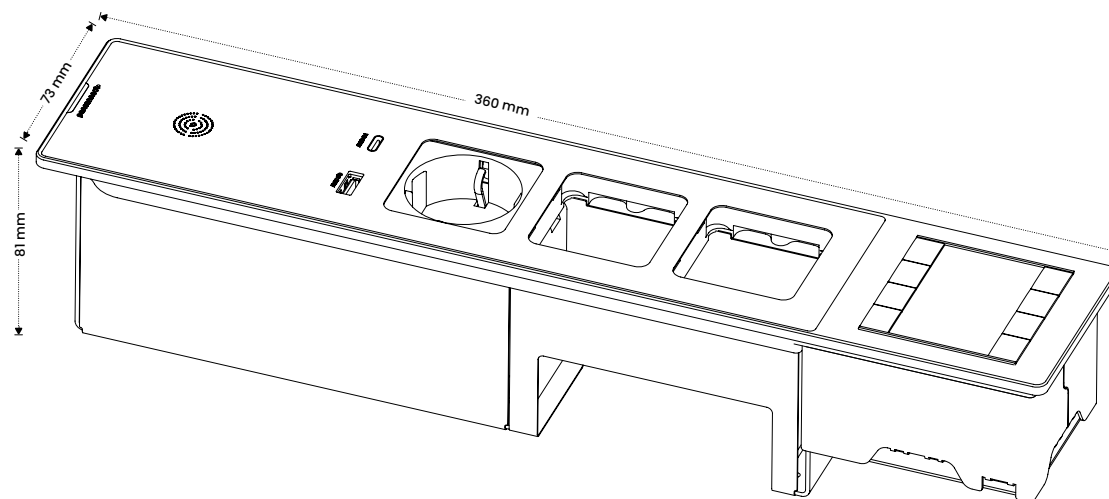

1740 g



ZDROJOVÝ KABEL

KABEL SE ZÁSTRČKOU



kabel se standardním typem zástrčky a délkou **1,9-4,9 m** není dostupný pro všechny světové standardy

WAGO miniWINSTA



25 cm dlouhý pigtail kabel s WINSTA mini plug 2+PE wiring | 10A

WIELAND GST18



25 cm dlouhý pigtail kabel s GST18i3 plug 2+PE wiring | 10A

CO NALEZNETE V BALENÍ ?

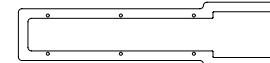

1 x montážní rámec pro instalaci

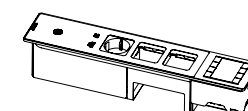

1 x panel s vybraným zdrojovým kabelem

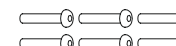

6 x montážní šroub v 6 možných velikostech (v závislosti na montážní výšce stolu)

MODULAR

FLAT by panconnect | 06

MODULES

by panconnect®

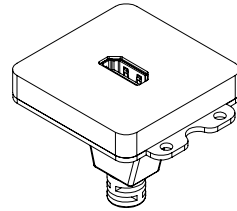

**HDMI
HDMI2.0b**

F/F
4K 60HZ
150mm
gold plated
awg32/22
black pvc

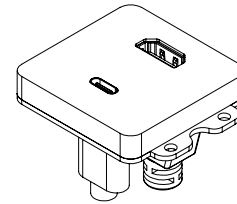

**USB-C 3.2
GEN 2**

M/F
10Gbps
150mm
gold and nickel plated
black pvc

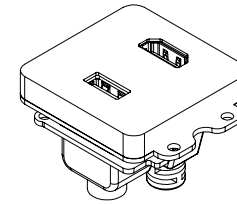

**USB-A 3.0
GEN 2**

F/F
5Gbps | 135mm
gold and nickel plated
AWG 28/28
black pvc

**HDMI
HDMI2.0b**

F/F | 4K 60HZ
150mm | gold plated
awg32/22
black pvc

**HDMI
HDMI2.0b**

F/F | 4K 60HZ
150mm | gold plated
awg32/22
black pvc

XLR

XLR socket MALE
16 A
direct 3pin solder-on
25mm
nickled
Black PLA

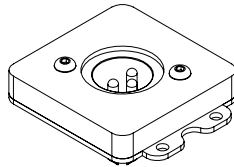

**VGA
DDC2 and EDID support**

F/F
HD
150mm
15pin
black pvc

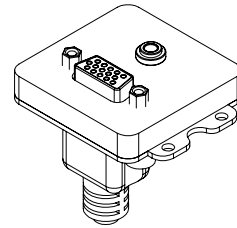

AUDIO

F/F | 3,5mm jack
3 PIN 0,35mm
150mm
goldplated
black pvc

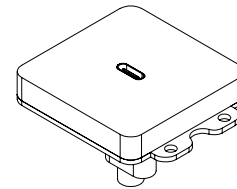

**USB-C 3.2
GEN 2**

M/F
10Gbps
150mm
gold and nickel plated
black pvc

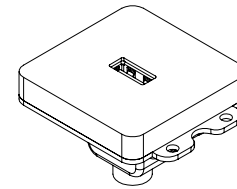

**USB-A 3.0
GEN 2**

F/F
5Gbps | 135mm
gold and nickel plated
AWG 28/28
black pvc

BAREVNOST



Onyx Black



Cotton White



Alu Silver

LAN

CAT 6A

coupler RJ45 | up to 500MHz,
10GBase-T | Gold-plated
360° shielded
connection
Fully shielded
metal housing

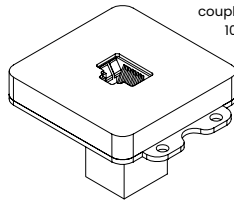

LAN

CAT 6A

coupler RJ45 | up to 500MHz,
10GBase-T | Gold-plated
360° shielded
connection
Fully shielded
metal housing

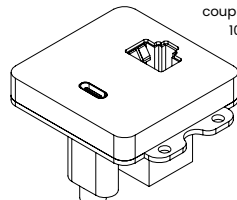

**USB-C 3.2
GEN 2**

M/F
10Gbps | 150mm
gold and nickel plated
black pvc

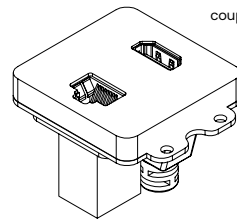

LAN

CAT 6A

coupler RJ45 | up to 500MHz,
10GBase-T | Gold-plated
360° shielded
connection
Fully shielded
metal housing

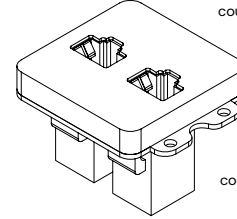

LAN

CAT 6A

coupler RJ45 | up to 500MHz,
10GBase-T | Gold-plated
360° shielded
connection
Fully shielded
metal housing

LAN

CAT 6A

coupler RJ45 | up to 500MHz,
10GBase-T | Gold-plated
360° shielded
connection | Fully shielded | metal housing

LAN

CAT 6A

coupler RJ45 | up to 500MHz,
10GBase-T | Gold-plated
360° shielded
connection
Fully shielded
metal housing

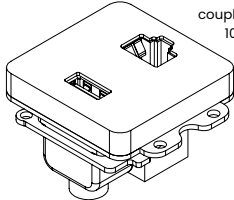

**USB-A 3.0
GEN 2**

F/F
5Gbps | 135mm
gold and nickel plated
AWG 28/28 | black pvc

PASS-THRU

vhodné pro kabely
do tloušťky typu
IEC 320 C14

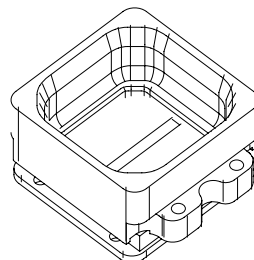

CABLE NECK

pull-out
connector
modul

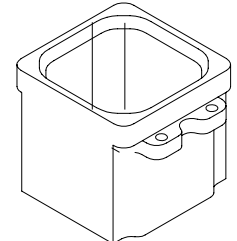

BLANK

PŘÁZDNÁ POZICE
PRO PŘÍPADNÉ
POZDĚJŠÍ POUŽITÍ

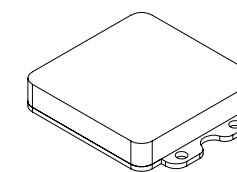

PULL-OUT SYSTEM

by panconnect•

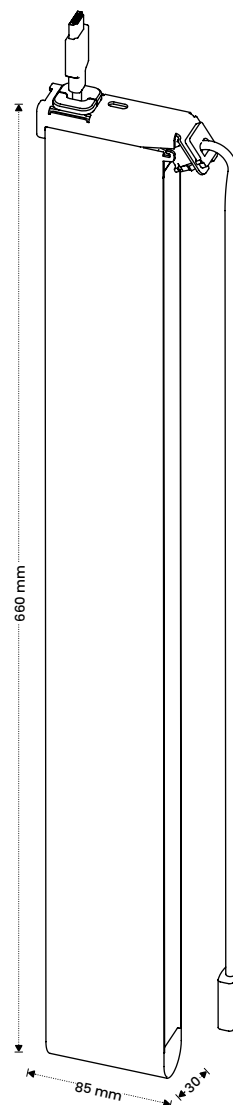

PULL-OUT - mechanismus, který funguje na principu gravitačního závaží v textilním vaku a povoluje vytažení kabelu **až do 96cm** (celková délka kabelu je 200 cm).
Umožňuje **zasouvání kabelu** pomocí závaží do designového vaku umístěného pod stolem.

ZÁVAŽÍ

SIZE S

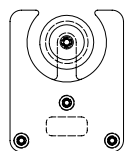

260 g

SIZE M

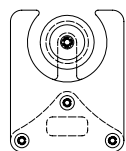

360 g

SIZE L

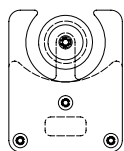

460 g

CO NALEZNETE V BALENÍ ?

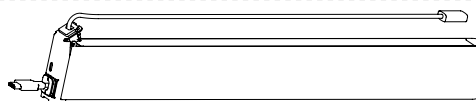

1 x pull-out system

KABELY

POČET KABELŮ K POUŽITÍ: 1-2

USB-C 3.2 (M-M)

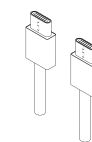

USB-C 3.2 gen 1
5Gbps | 200cm
gold and nickel plated
black pvc

USB-C 3.2 (M-F)

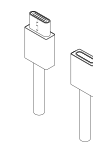

USB-C 3.2 gen 1
5Gbps | 200cm
gold and nickel plated
black pvc

USB-C (M) / HDMI (M)

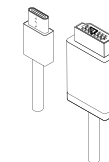

HDMI2.0 | 4K60Hz
200cm
gold-plated
AWG32 / 22 | black pvc

mini DISPLAY PORT (M) / HDMI (M)

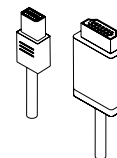

DP | 4K30Hz
200cm
4K/UHD/2160p@60Hz
black pvc

DISPLAY PORT (M-M)

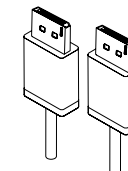

DPI.4 | 8K60Hz
200cm
gold-plated
AWG32 / 22 | black pvc

DISPLAY PORT (M) / HDMI (M)

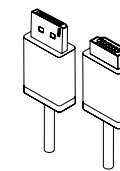

2K DP | WUXGA (1920x1200)
200cm
SECURE LOCK | gold-plated
AWG28 | black pvc

HDMI (M-M)

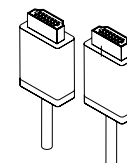

HDMI1.4 | 4K30Hz
200cm
gold-plated | AWG32 / 22
black pvc

HDMI (M-F)

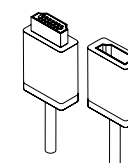

HDMI1.4 | 4K30Hz
200cm
gold-plated | AWG32 / 22
black pvc

USB 3.0 (M-F)

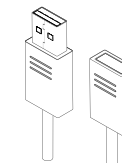

USB3.0 | 5Gbps
200cm
9pin
AWG28/28 | black pvc

LAN (M-M)

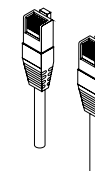

CAT6 RJ45 | UTP
200cm
CU 4x2
AWG26/7 | black pvc

BEZPEČNOST & RECYKLACE



PANCONNECT tímto prohlašuje, že přípojný panel **FLAT** vyhovuje směrnici o nízkém napětí (2014/35/EU) a také směrnici o Elektromagnetické kompatibilitě (2014/30 EU). Testování bylo provedeno dle norem EN 50491-5-1:2010, EN 50491-5-2:2010.



Produkty **PANCONNECT** jsou v souladu s politikou společnosti určeny k **upgradu**, nejlépe pak maximální **recyklaci**.



Než přistoupíte k likvidaci, ověřte si u nás, zda-li je možné produkt upgradovat nebo repasovat. Pokud to není možné zajistěte jeho likvidaci dle platných směrnic. Produkt spadá do skupiny **ODPAD Z ELEKTRONICKÝCH ZAŘÍZENÍ**, jeho likvidace je možná pouze v souladu s evropskou směrnicí 2012/19/EU a nelze jej likvidovat společně s komunálním odpadem. www.asekol.cz | info@asekol.cz

INSTRUKCE K INSTALACI



Jednoduchá instalace

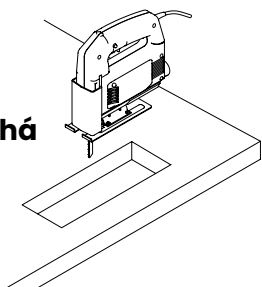

VÝŠKA DESKY STOLU

10 mm
to 40 mm
(až do 60mm s
vlastními šroubky)

Potřebujete: přímočarou pilu, vrtačku a vrták Ø 10mm

- 01** Naznačte 4 otvory dle šablony a vrtákem je vyvrtejte
- 02** Přimočarou pilou prořízněte jednotlivé otvory
- 03** Vložte panel do otvoru a zespodu nasadte rámeček a přitáhněte jej šroubky k panelu
- 04** Pokud jste ve svém panelu zvolili pull-out připevněte jej nyní do usazeného panelu

MODULAR

USB-C SPECIFIKACE

PowerDelivery up to 60W

USB-A SPECIFIKACE

QuickCharge 3.0 up to 5A

SPECIFIKACE ZÁSUVKY

230V/10A (EU), 110V/10A (US)

OCHRANA PROTI VNIKNUTÍ

IP22

ELEKTRICKÉ SPECIFIKACE VSTUPNÍ

110 - 250V, 10A

MODULARITA

MODULES | PASS-THRU | PULL-OUT

MATERIÁLY

Dural | nerezová ocel | FENIX NTM | kortexin

DESIGNER

Dominik Hutečka

Designed & manufactured in Brno, Czech Republic.

PANCONNECT s.r.o. | Olomoucká 51, Brno | Czech Republic
www.panconnect.eu | support@panconnect.eu

panconnect