

# FLAT

by panconnect.

**FLAT** is a basic but very universal panel that can be placed on working places, conference tables, and in conference rooms. This product can be used practically everywhere where universal connectivity is needed. When there is a requirement for maximum modularity, low installation depth and easy installation, FLAT is the right choice. PANCONNECT offers 5 sizes of this product.

**FLAT LITE** contains only sockets or combination of sockets and connector modules (alternatively PULL-OUT cables). Three other sizes - **FLAT M**, **L** and **XL** can be used depending

on the connectivity requirements and number of sockets that are needed.

All the panels include **USB - A and USB - C (60W)** charging slots, alternatively Qi charging that is integrated directly in the panel.

**FLAT PLUS** includes on top of that third party's active module (for size from 45 to 55 mm), typically a control compact system.

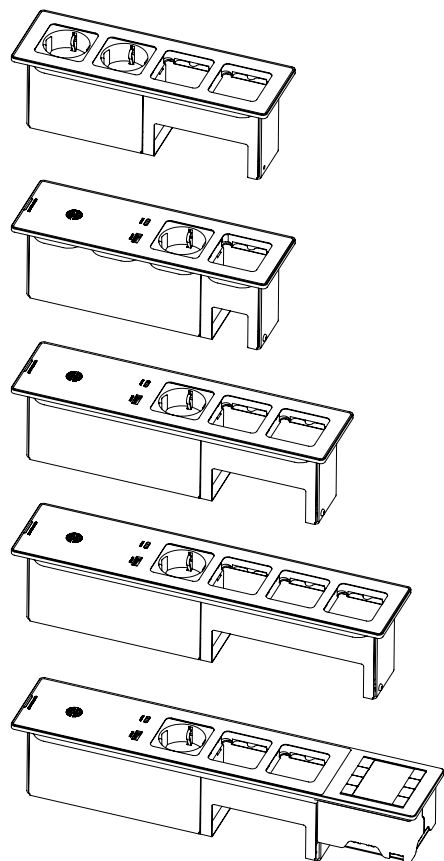

	DIMENSION	WEIGHT	MAX. NUMBER OF SOCKETS	MAX. NUMBER OF MODULES	POSSIBILITY OF Qi WIRELESS CHARGING	ADAPTER FOR CONTROL SYSTEM	DIMENSION WITH PULL-OUT CABLE SYSTEM
LITE	227,5 × 73 × 81 mm	760 g	4	2	×	×	227,5 × 73 × 690 mm
M	227,5 × 73 × 81 mm	1150 g	2	1	✓	×	227,5 × 73 × 690 mm
L	279 × 73 × 81 mm	1260 g	3	2	✓	×	279 × 73 × 690 mm
XL	330,5 × 73 × 81 mm	1370 g	4	3	✓	×	330,5 × 73 × 690 mm
PLUS	360 × 73 × 81 mm	1740 g	3	2	✓	BIAMP (NEETS) CUE	360 × 73 × 690 mm

# FLAT

by panconnect

LITE

## SOCKETS

NUMBER OF SOCKETS:

2-4

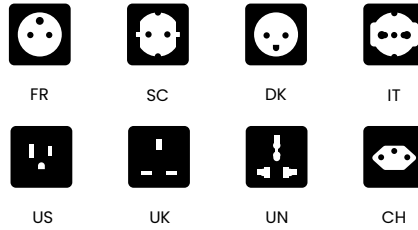

## MODULES

NUMBER OF MODULES:

0-2

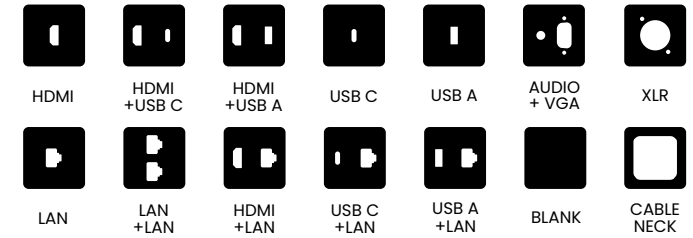

760 g

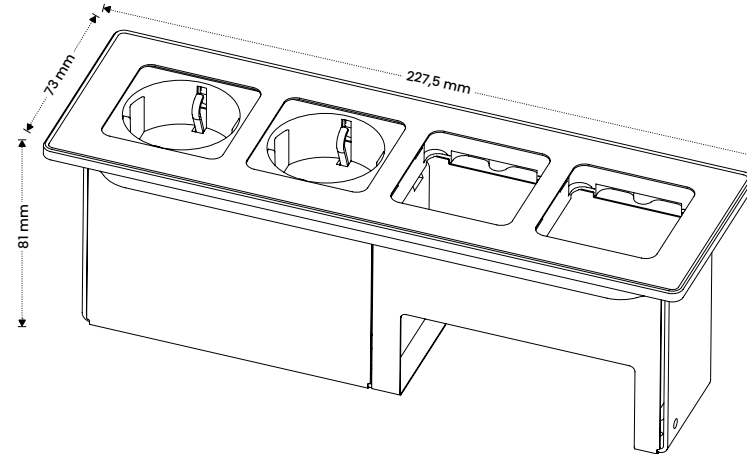

## COLOURS



Onyx Black



Cotton White



Alu Silver

## POWER CABLES

POWER PLUG



cable with standard plug type a  
cable length 1,9 to 4,9m)  
*not available for all standards*

WAGO miniWINSTA



25 cm long pigtail  
cable with WINSTA mini plug  
2+PE wiring | 10A

WIELAND GST18



25 cm long pigtail  
cable with GST18i3 plug  
2+PE wiring | 10A

## WHAT IS INCLUDED IN THE PACKAGE ?

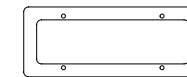

1 x mounting frame for installation

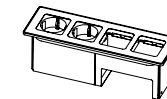

1 x panel with chosen power cables

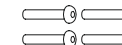

4 x mounting screws in 6 possible sizes (depending on the the desk mounting height)

MODULAR

# FLAT

by panconnect

SIZE M

## SOCKETS

NUMBER OF SOCKETS:

1-2

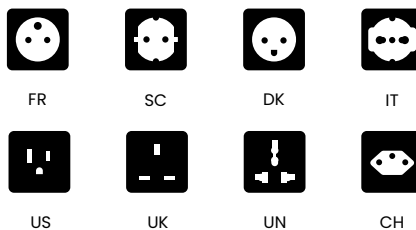

## MODULES

NUMBER OF MODULES:

0-1

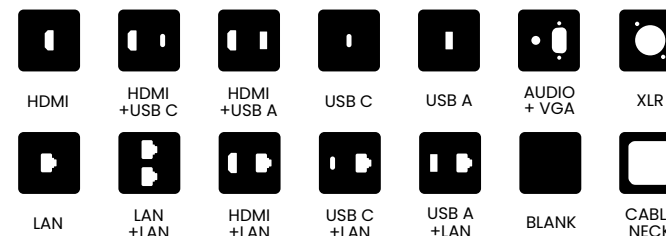

1150 g

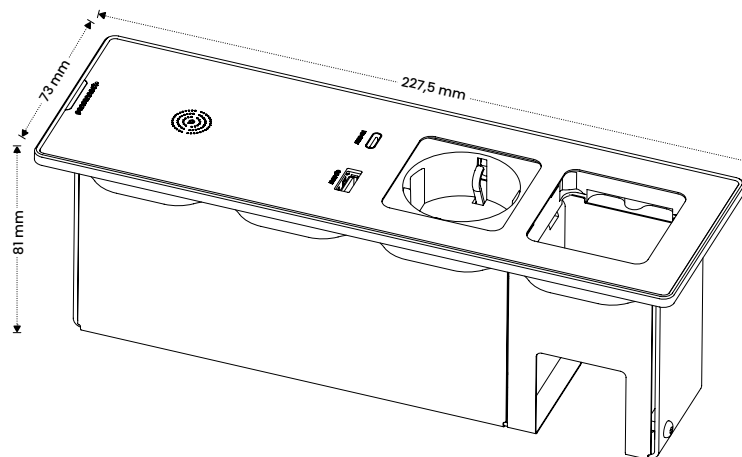

## COLOURS



Onyx Black



Cotton White



Alu Silver

## WIRELESS CHARGING

Qi compliant 1.5A/5V

WITH INTEGRATED QI

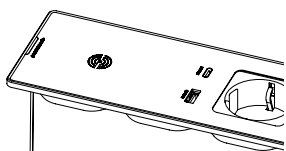

WITHOUT INTEGRATED QI

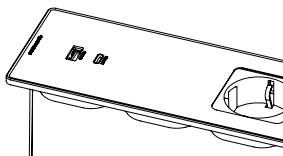

## POWER CABLES

KABEL SE ZÁSTRČKOU



cable with standard plug type type-m and cable length 1,9-4,9 m  
not available for all standards

WAGO miniWINSTA



25 cm long pigtail cable with WINSTA mini plug 2+PE wiring | 10A

WIELAND GST18



25 cm long pigtail cable with GST18i3 plug 2+PE wiring | 10A

## WHAT IS INCLUDED IN THE PACKAGE ?

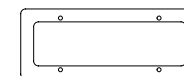

1 × mounting frame for installation

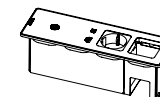

1 × panel with chosen power cable

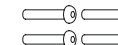

4 × mounting screws in 6 possible sizes (depending on the desk mounting height)



MODULAR

# FLAT

by panconnect

SIZE L

## COLOURS



Onyx Black



Cotton White



Alu Silver

## WIRELESS CHARGING

Qi compliant 1.5A/5V

### WITH INTEGRATED QI

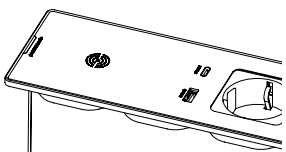

### WITHOUT INTEGRATED QI

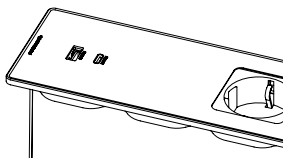

## MODULAR

## SOCKETS

NUMBER OF SOCKETS:

1-3



FR



SC



DK



IT



US



UK



UN



CH

## MODULES

NUMBER OF MODULES:

0-2



HDMI



HDMI + USB C



HDMI + USB A



USB C



USB A



AUDIO + VGA



XLR



LAN



LAN + LAN



HDMI + LAN



USB C + LAN



USB A + LAN



BLANK



CABLE NECK

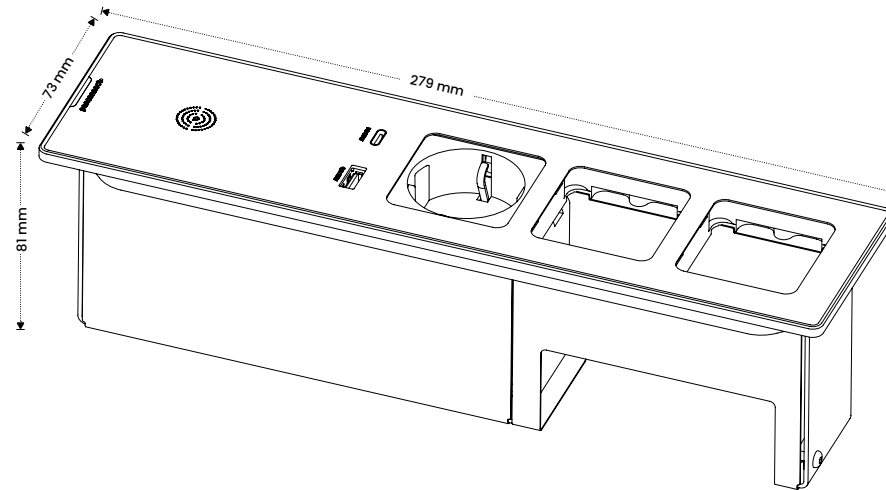

1260 g



## POWER CABLES

### POWER PLUG

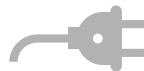

cable with standard plug type  
a cable length 1,9 to 4,9m) -  
**not available for all standards**

### WAGO miniWINSTA



**25 cm dlouhý pigtail**  
kabel s WINSTA mini plug  
2+PE wiring | 10A

### WIELAND GST18

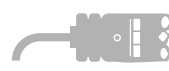

**25 cm long pigtail**  
cable with GST18i3 plug  
2+PE wiring | 10A

## WHAT IS INCLUDED IN THE PACKAGE ?

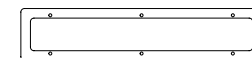

1 × mounting frame for installation

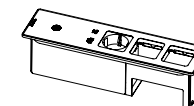

1 × panel with chosen power cable

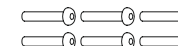

6 × mounting screws in 6 possible sizes (depending on the desk mounting height)

# FLAT

by panconnect

SIZE XL

## COLOURS



Onyx Black



Cotton White



Alu Silver

## WIRELESS CHARGING

Qi compliant 1.5A/5V

### WITH INTEGRATED QI

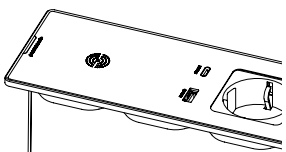

### WITHOUT INTEGRATED QI

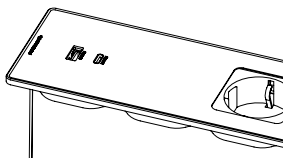

MODULAR

## SOCKETS

NUMBER OF SOCKETS:

1-4



FR



SC



DK



IT



US



UK



UN



CH

## MODULES

NUMBER OF MODULES:

0-3



HDMI



HDMI + USB C



HDMI + USB A



USB C



USB A



AUDIO + VGA



XLR



LAN



LAN + LAN



HDMI + LAN



USB C + LAN



USB A + LAN



BLANK



CABLE NECK



1370 g

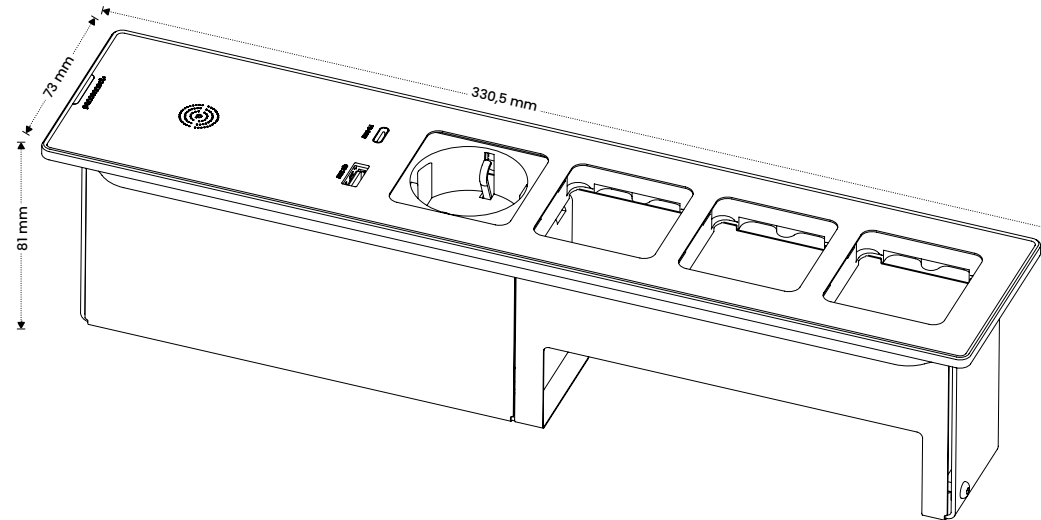

## POWER CABLES

### POWER PLUG



cable with standard plug type a cable length 1,9 to 4,9m) - **not available for all standards**

### WAGO miniWINSTA



**25 cm long pigtail** cable with WINSTA mini plug 2+PE wiring | 10A

### WIELAND GST18

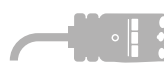

**25 cm long pigtail** cable with GST18i3 plug 2+PE wiring | 10A

## WHAT IS INCLUDED IN THE PACKAGE ?

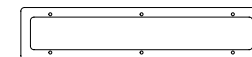

1 × mounting frame for installation

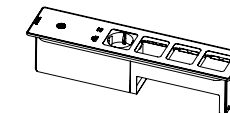

1 × panel with chosen power cable

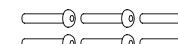

6 × mounting screws in 6 possible sizes (depending on the desk mounting height)

# FLAT

by panconnect®

PLUS

## CONTROL SYSTEM

### BIAMP NEEDS



Ready for easy installation of standard 55 × 55 mm control system from Biamp/Neets (BraVo, OsCar, Echo, Sierra)

### CUE



Ready for installation of small wired 8-button keypad CUE-55 from CUE systems

### VLASTNÍ INTEGRACE



Other control system up to 55 × 55 mm size supported. For more information please contact your sales rep.

## COLOURS



Onyx Black



Cotton White



Alu Silver

## WIRELESS CHARGING

Qi compliant 1.5A/5V

### WITH INTEGRATED QI

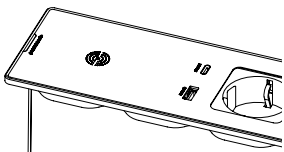

### WITHOUT INTEGRATED QI

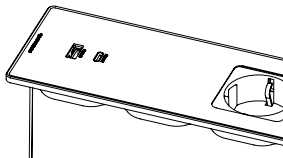

MODULAR

## SOCKETS

NUMBER OF SOCKETS:

1-3



FR



SC



DK



IT



US



UK



UN



CH

## MODULES

NUMBER OF MODULES:

0-2



HDMI



HDMI + USB C



HDMI + USB A



USB C



USB A



AUDIO + VGA



XLR



LAN



LAN + LAN



HDMI + LAN



USB C + LAN



USB A + LAN



BLANK



CABLE NECK

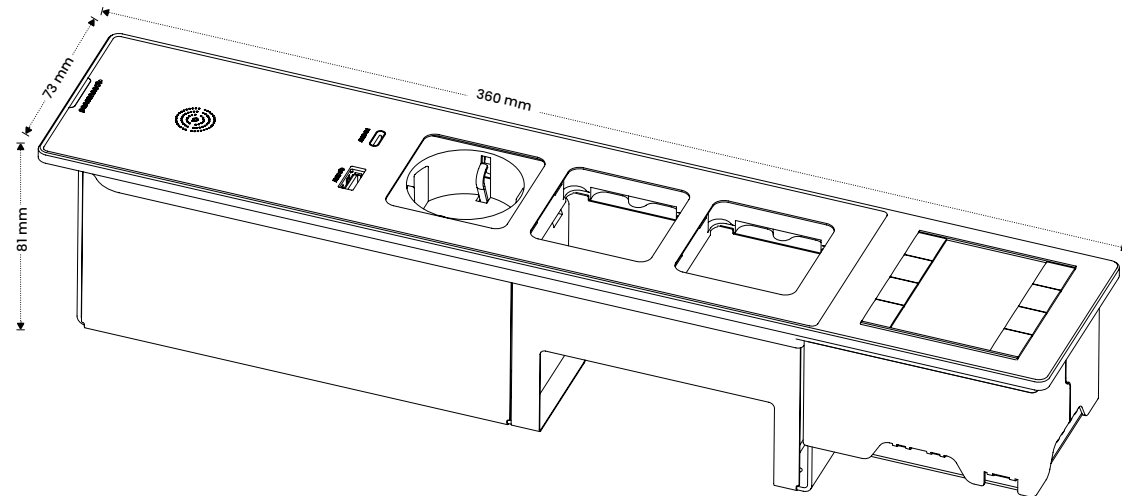

1740 g



## POWER CABLES

### POWER PLUG



cable with standard plug type a cable length 1,9 to 4,9m) - **not available for all standards**

### WAGO miniWINSTA



**25 cm LONG pigtail** cable with WINSTA mini plug 2+PE wiring | 10A

### WIELAND GST18



**25 cm long pigtail** cable with GST18i3 plug 2+PE wiring | 10A

## WHAT IS INCLUDED IN THE PACKAGE ?

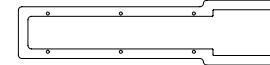

1 × mounting frame for installation

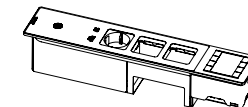

1 × panel with chosen power cable

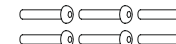

6 × mounting screws in 6 possible sizes (depending on the desk mounting height)

# MODULES

by panconnect®

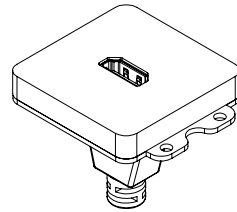

**HDMI  
HDM12.0b**  
F/F  
4K 60HZ  
150mm  
gold plated  
awg32/22  
black pvc

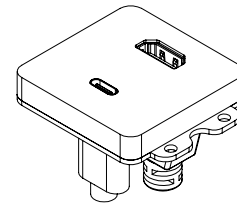

**USB-C 3.2  
GEN 2**  
M/F  
10Gbps  
150mm  
gold and nickel plated  
black pvc

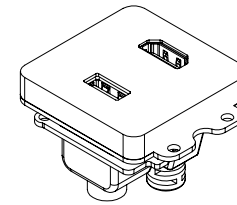

**USB-A 3.0  
GEN 2**  
F/F  
5Gbps | 135mm  
gold and nickel plated  
AWG 28/28  
black pvc

**HDMI  
HDM12.0b**  
F/F | 4K 60HZ  
150mm | gold plated  
awg32/22  
black pvc

**HDMI  
HDM12.0b**  
F/F | 4K 60HZ  
150mm | gold plated  
awg32/22  
black pvc

## XLR

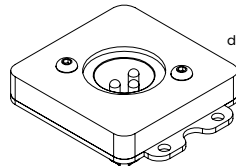

XLR socket FEMALE  
16 A  
direct 3pin solder-on  
25mm  
nickled  
Black PLAW

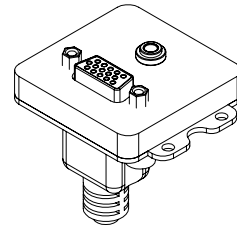

**VGA  
DDC2 and EDID support**  
F/F  
HD  
150mm  
15pin  
black pvc

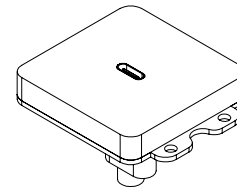

**USB-C 3.2  
GEN 2**  
M/F  
10Gbps  
150mm  
gold and nickel plated  
black pvc

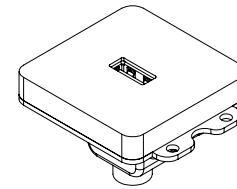

**USB-A 3.0  
GEN 2**  
F/F  
5Gbps | 135mm  
gold and nickel plated  
AWG 28/28  
black pvc

**AUDIO**  
F/F | 3,5mm jack  
3 PIN 0,35mm  
150mm  
goldplated  
black pvc

## COLOURS



Onyx Black



Cotton White



Alue Silver

## LAN

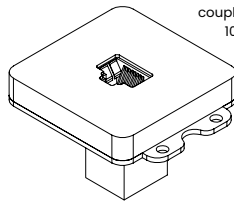

**CAT 6A**  
coupler RJ45 | up to 500MHz,  
10GBase-T | Gold-plated  
360° shielded  
connection  
Fully shielded  
metal housing

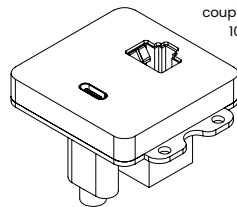

**LAN  
CAT 6A**  
coupler RJ45 | up to 500MHz,  
10GBase-T | Gold-plated  
360° shielded  
connection  
Fully shielded  
metal housing

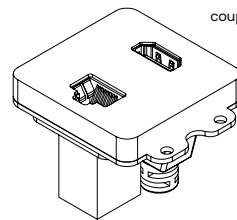

**LAN  
CAT 6A**  
coupler RJ45 | up to 500MHz,  
10GBase-T | Gold-plated  
360° shielded  
connection  
Fully shielded  
metal housing

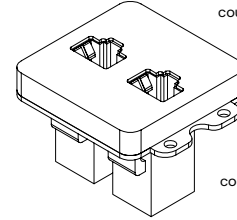

**LAN  
CAT 6A**  
coupler RJ45 | up to 500MHz,  
10GBase-T | Gold-plated  
360° shielded  
connection  
Fully shielded  
metal housing

**USB-C 3.2  
GEN 2**  
M/F  
10Gbps | 150mm  
gold and nickel plated  
black pvc

**HDMI  
HDM12.0b**  
F/F | 4K 60HZ  
150mm | gold plated  
awg32/22  
black pvc

**LAN  
CAT 6A**  
coupler RJ45 | up to 500MHz,  
10GBase-T | Gold-plated  
360° shielded  
connection | Fully shielded | metal housing

## LAN

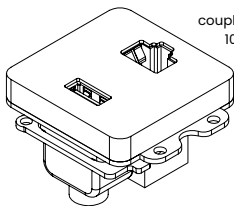

**CAT 6A**  
coupler RJ45 | up to 500MHz,  
10GBase-T | Gold-plated  
360° shielded  
connection  
Fully shielded  
metal housing

**USB-A 3.0  
GEN 2**  
F/F  
5Gbps | 135mm  
gold and nickel plated  
AWG 28/28 | black pvc

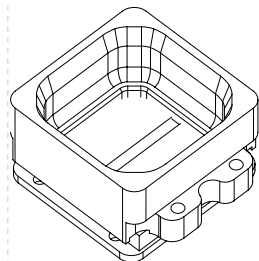

**PASS - THRU**  
suitable for  
thickness of the cable  
up to  
IEC 320 C14

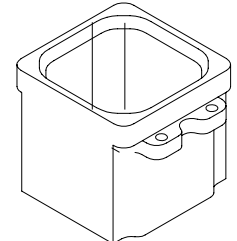

**CABLE NECK**  
pull-out  
connector  
modul

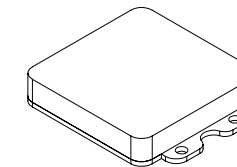

**BLANK**  
PŘÁZDNÁ POZICE  
PRO PŘÍPADNÉ  
POZDĚJŠÍ POUŽITÍ

# PULL-OUT SYSTEM

by panconnect•

**PULL-OUT** - A mechanism that works on the principle of gravity weighted cables in a textile bag and it allows the cable to be pulled up to 96 cm (the total length of the cable is 200 cm).

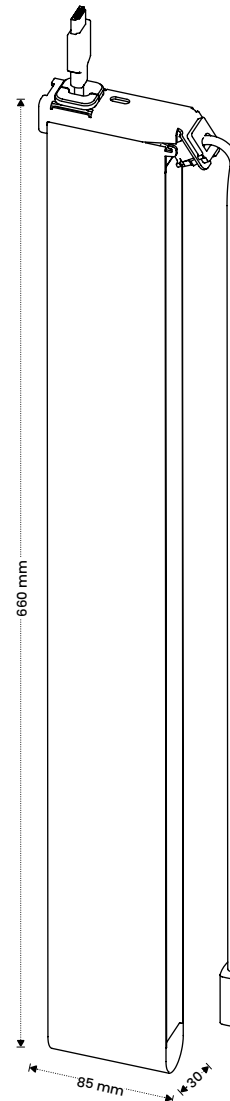

## WEIGHT

SIZE S

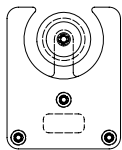

260 g

SIZE M

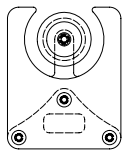

360 g

SIZE L

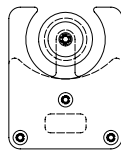

460 g

## WHAT IS INCLUDED IN THE PACKAGE ?

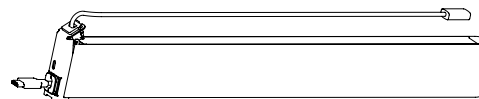

1 x pull-out system

## CABLES

NUMBER OF CABLES:

1-2

### USB-C 3.2 (M-M)

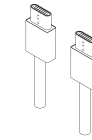

USB-C 3.2 gen 1  
5Gbps | 200cm  
gold and nickel plated  
black pvc

### USB-C 3.2 (M-F)

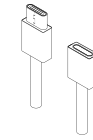

USB-C 3.2 gen 1  
5Gbps | 200cm  
gold and nickel plated  
black pvc

### USB-C (M) / HDMI (M)

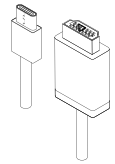

HDMI2.0 | 4K60Hz  
200cm  
gold-plated  
AWG32 / 22 | black pvc

### mini DISPLAY PORT (M) / HDMI (M)

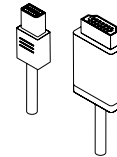

DP | 4K30Hz  
200cm  
4K/UHD/2160p@60Hz  
black pvc

### DISPLAY PORT (M-M)

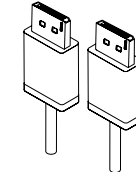

DPI.4 | 8K60Hz  
200cm  
gold-plated  
AWG32 / 22 | black pvc

### DISPLAY PORT (M) / HDMI (M)

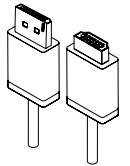

2K DP | WUXGA (1920x1200)  
200cm  
SECURE LOCK | gold-plated  
AWG28 | black pvc

### HDMI (M-M)

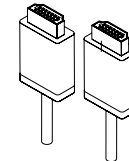

HDMI1.4 | 4K30Hz  
200cm  
gold-plated | AWG32 / 22  
black pvc

### HDMI (M-F)

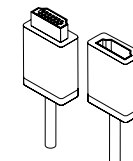

HDMI1.4 | 4K30Hz  
200cm  
gold-plated | AWG32 / 22  
black pvc

### USB 3.0 (M-F)

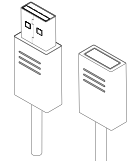

USB3.0 | 5Gbps  
200cm  
9pin  
AWG28/28 | black pvc

### LAN (M-M)

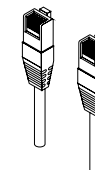

CAT6 RJ45 | UTP  
200cm  
CU 4x2  
AWG26/7 | black pvc



# SAFETY & RECYCLATION



PANCONNECT declares that panel FLAT complies with Low voltage directive 2014/35/EC and EMC directive 2014/30/EU. Testing has been made according to EN 50491-5-1:2010 and EN 50491-5-2:2010 standards.



All products from PANCONNECT are intended for upgrade or recycling in accordance with the company's policy.



Before the disposal of this panel comes up, please verify if this product can or cannot be upgraded or overhauled. If it's not possible, kindly arrange the disposal in accordance with valid EU directives. This product belongs to WASTE ELECTRICAL AND ELECTRONIC EQUIPMENT (WEEE) category so the disposal is possible only in accordance with this WEEE Directive 2012/19/EU. It cannot be part of the municipal waste. For more information please check [www.asekol.cz](http://www.asekol.cz) | [info@asekol.cz](mailto:info@asekol.cz)

## INSTALLATION MANUAL



### Easy installation

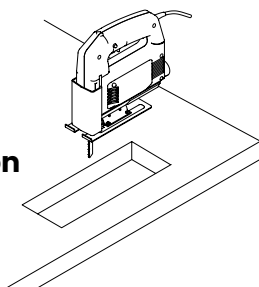

**DESK MOUNTING HEIGHT**  
10 mm  
to 40 mm  
(up to 60mm with custom screws)

**Tools: jig saw, drill and bit Ø 10mm**

- 01| Mark 4 holes according to the cutout and drill them with the bit
- 02| Take a jig saw and cut the holes
- 03| Put the panel to the hole and place the metal frame over the bottom part of the panel and tighten the screws
- 04| If you've chosen PULL-OUT system for your panel, add it now

### USB-C SPECIFICATION

PowerDelivery up to 60W

### USB-A SPECIFICATION

QuickCharge 3.0 up to 5A

### SOCKETS

230V/10A (EU), 110V/10A (US)

### INGRESS PROTECTION

IP22

### POWER SUPPLY

110 - 250V, 10A

### MODULARITY

MODULES | PASS-THRU | PULL-OUT

### MATERIALS

Dural | stainless steel | FENIX NTM | kortexin

### DESIGNER

Dominik Hutečka