

# UNI

by panconnect.

**UNI** už podle názvu nabízí nejvíce univerzální konfiguraci pro náročné audio-video aplikace i jednoduchou designovou konektivitu na pracovních místech, jednacích stolech, katedrách a konferenčních místnostech. Je v nabídce ve třech barevných provedeních.

Obě velikosti **UNI** (UNI4 a UNI6 podle počtu pozic) umožňují osazení různých variant **CARTRIDGE**, která obsahuje silovou část se zásuvkami a variantně **USB-A** a **USB-C** (60W) napájecími porty. Panel se osazuje vždy cartridge se zásuvkami a volitelně i konektorovými moduly a systémem s vytahovacími kabely. Pro **UNI4** je možné také využít jen cartridge se zásuvkami a moduly na celou šířku panelu. **Panel UNI** umožňuje rovněž integraci řídicích systémů pomocí speciálního dvojmodulu.

Pro manipulaci s kabely je možné využít 2 typy mechanismů: **kabelový RETRACTOR a PULL-OUT**. **PULL-OUT systém** funguje na principu gravitačního závaží v textilním vaku a povoluje vytažení kabelu až do 96cm (celková délka kabelu je 200 cm). Vyrábí se v 2, 4 a 6-ti kabelovém provedení, kdy dva kabely zabírají jednu pozici v panelu. **Kabelový RETRACTOR** je kompaktní motorický navíjecí mechanismus až do délky kabelu 138 cm (celková délka kabelu 300 cm) s chytrou elektronikou, která maximalizuje lehkost vytažení kabelu a po stisku tlačítka zajistí jeho automatické zatažení.

ROZMĚR PANELU	VÁHA PANELU	MAX. POČET ZÁSUVEK	MAX. POČET MODULKŮ	KABELOVÝ SYSTÉM PULL-OUT	ROZMĚR PANELU S KABELOVÝM SYSTÉMEM PULL-OUT	KABELOVÝ RETRACTOR	MOŽNOST ADAPTÉRU PRO ŘÍDÍCÍ SYSTÉM
---------------	-------------	--------------------	--------------------	--------------------------	---	--------------------	------------------------------------

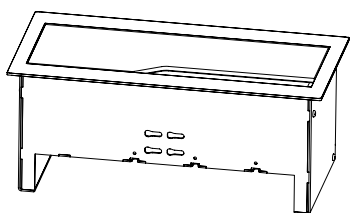

UNI 4

282 × 124 × 112 mm	6100 g	4	2	až 4	282 × 124 × 700 mm	až 2	BIAMP Neets   Cue
--------------------	--------	---	---	------	--------------------	------	----------------------

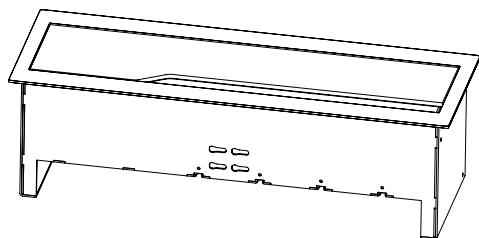

UNI 6

390,8 × 124 × 112 mm	9200 g	6	3	až 6	390,8 × 124 × 700 mm	až 3	BIAMP Neets   Cue
----------------------	--------	---	---	------	----------------------	------	----------------------

# JAK SI SESTAVIT UNI VE 4 KRÁTKÝCH KROCÍCH

PRO SNADNOU  
ONLINE KONFIGURACI  
PANELU UNI  
NAVŠTIVTE  
PANCONNECT.EXPIVI.NET



1| ZVOLTE VELIKOST,  
BARVU A TVAR ŠASI  
A ŘÍDÍCÍ SYSTÉM



2| VYBERTE SI VYHOVUJÍCÍ TYP  
CARTRIDGE PRO VÁŠ PANEL



3| DOPLŇTE DO VAŠEHO PANELU  
NAVÍJECÍ SYSTÉM KABELŮ



4| VYBERTE TYP ZDROJOVÝ KABELU,  
TAK JAK VÁM VYHOVUJE

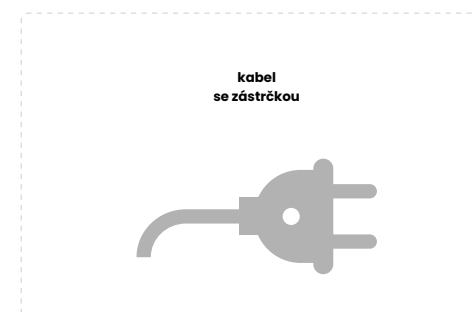
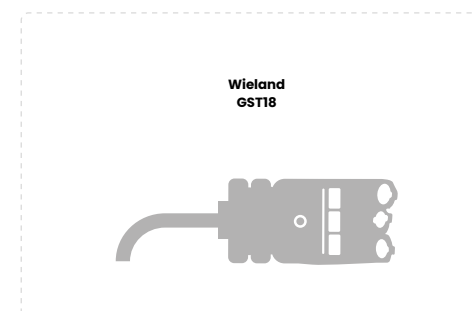
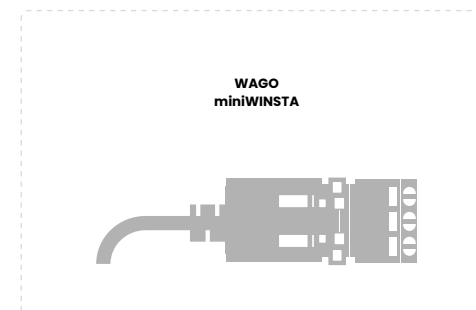
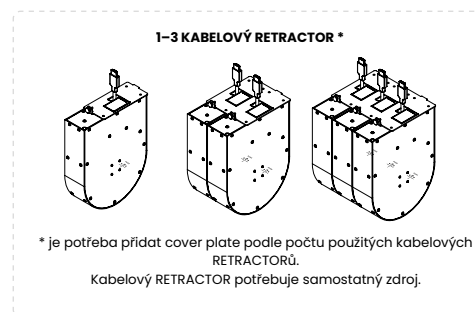
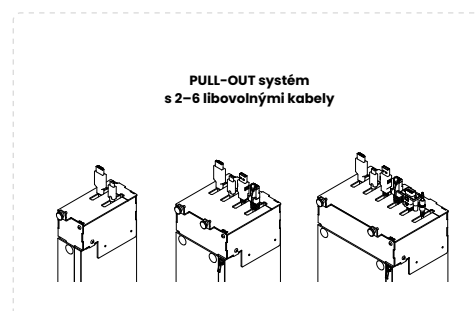
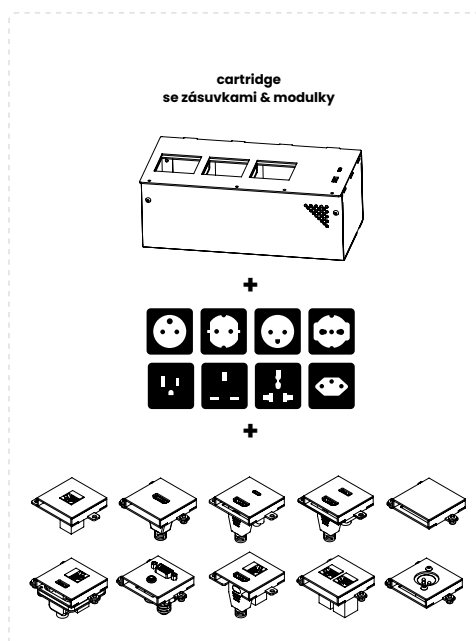
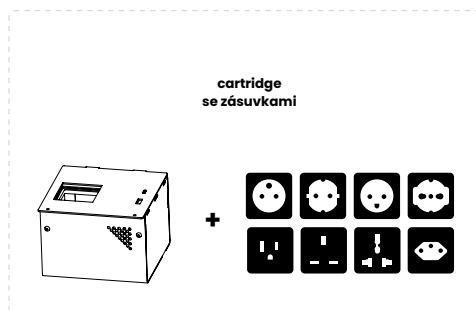
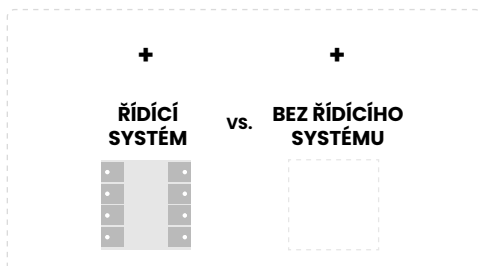
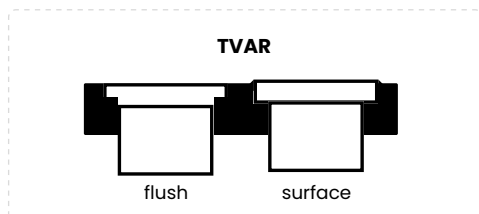
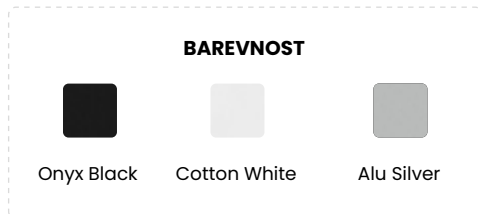
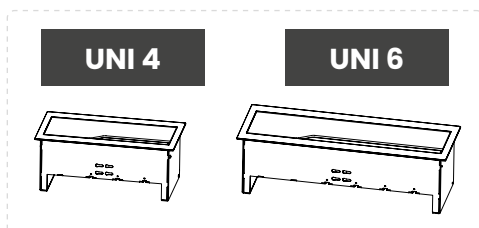

# UNI

by panconnect•



## UNI 4



6100 g

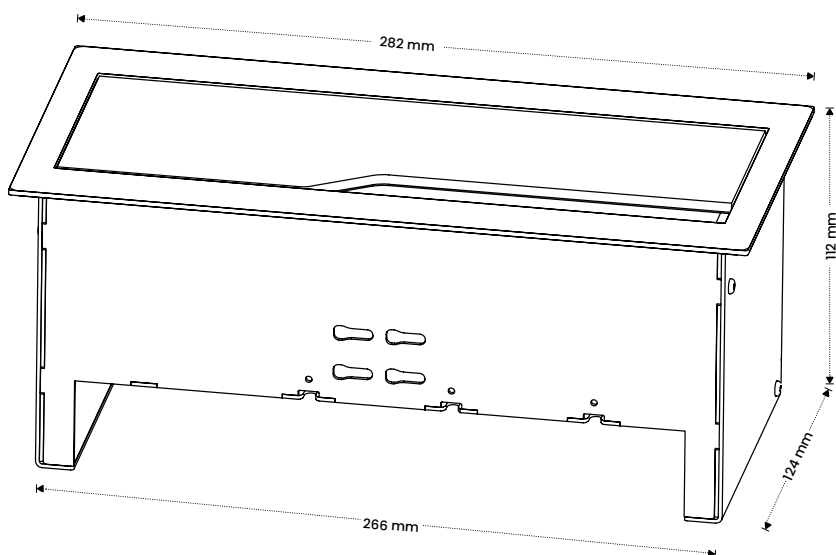

## UNI 6



9200 g

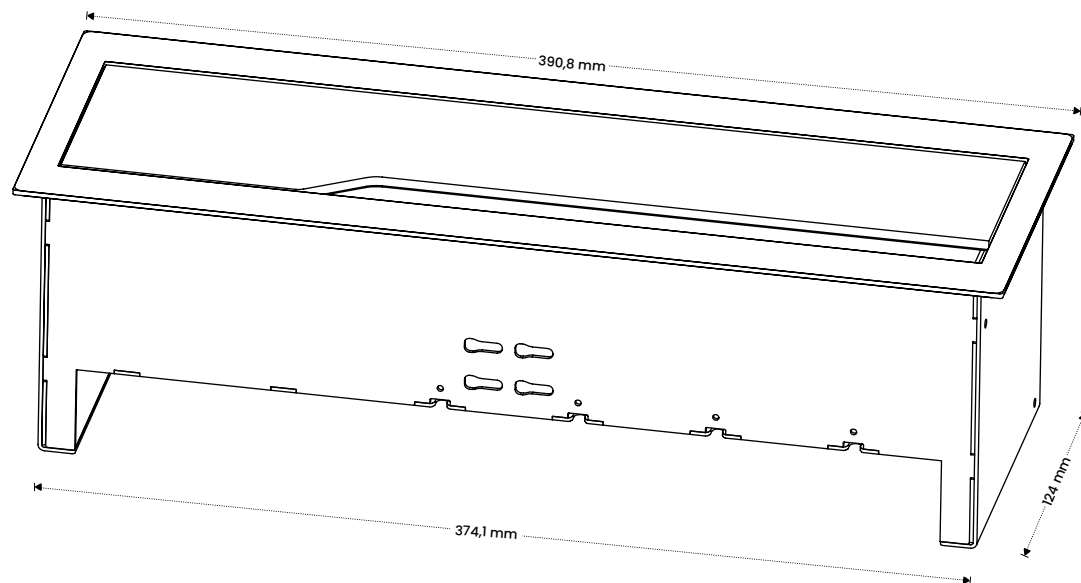

### BAREVNOST



Onyx Black



Cotton White



Alu Silver

### ŘÍDÍCÍ SYSTÉM

#### BIAMP NEETS



Připraveno pro snadnou instalaci standardního ovládacího 55 x 55 systémů od Biamp/Neets (BraVo, OsCar, Echo, Sierra).

#### CUE



Připraveno k instalaci malé drátové 8-mi tlačítkové klávesnice CUE-55 od CUE systému.

#### VLASTNÍ INTEGRACE



Podpora jiných řídicích systémů do velikosti 55 x 55 mm. Pro více podrobností prosím kontaktujte vašeho prodejce.

### CO NALEZNETE V BALENÍ ?

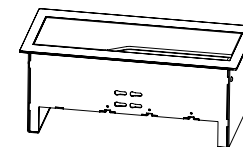

1x chassis panelu UNI

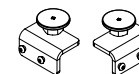

2 x uchycení ke stolu

MODULAR

# CARTRIDGE

## BEZ MODULKŮ

by panconnect•



### BAREVNOST



Onyx Black



Cotton White



Alu Silver

### ZÁSUVKY

POČET ZÁSUVEK K POUŽITÍ: 1-6



FR



SC



DK



IT



US



UK



UN



CH

### ZDROJOVÝ KABEL

KABEL SE  
ZÁSTRČKOU



kabel se standardním typem zástrčky a délkou 1,9-4,9 m není dostupný pro všechny světové standardy

WAGO  
miniWINSTA



25 cm dlouhý pigtail kabel s WINSTA mini plug 2+PE wiring | 10A

WIELAND  
GST18

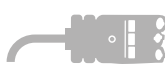

25 cm dlouhý pigtail kabel s GST1813 plug 2+PE wiring | 10A

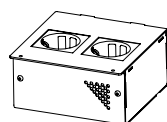

**CRT 2 S**

2× zásuvka

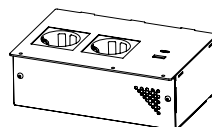
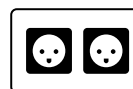

**CRT 3 C+A**

2× zásuvka + USB-C/A

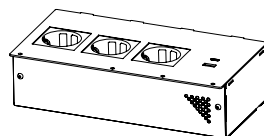
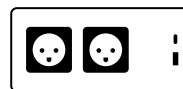

**CRT 4 C+A**

3× zásuvka + USB-C/A

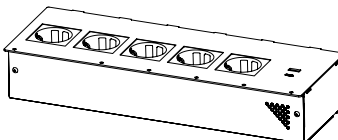
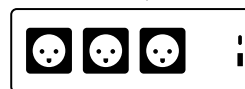

**CRT 6 C/A**

5× zásuvka + USB-C/A

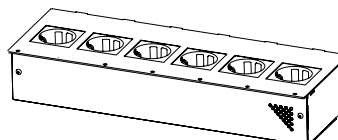
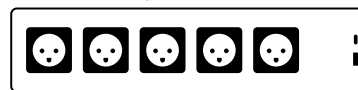

**CRT 6 S**

6× zásuvka

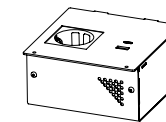
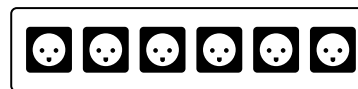

**CRT 2 C+A**

1× zásuvka + USB-C/A

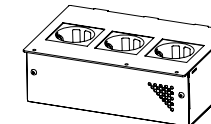

**CRT 3 S**

3× zásuvka

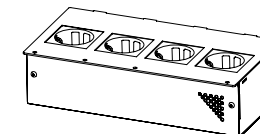
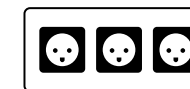

**CRT 4 S**

4× zásuvka

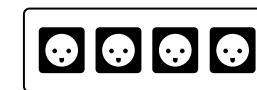

# CARTRIDGE

## S MODULKY

by panconnect•



### BAREVNOST



Onyx Black



Cotton White



Alu Silver

### ZÁSUVKY

POČET ZÁSUVEK K POUŽITÍ: 1-5



FR



SC



DK



IT



US



UK



UN



CH

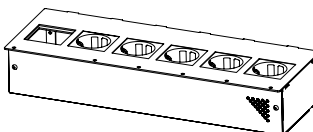
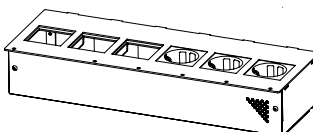
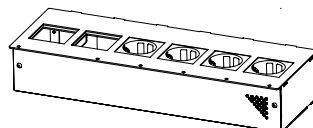
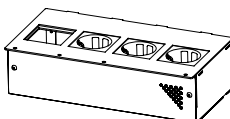
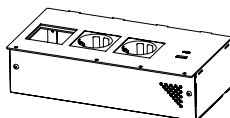
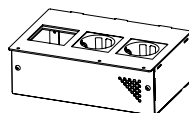

### CRT 3 MS

1x modulek + 2x zásuvka

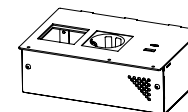

### CRT 4 M C+A

1x modulek + 2x zásuvka + USB-C/A

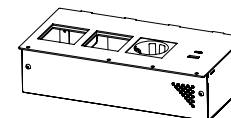
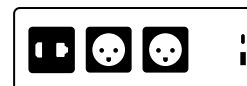

### CRT 4 MS

1x modulek + 3x zásuvka

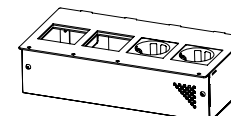
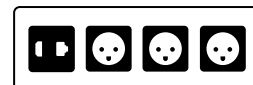

### CRT 3 M C+A

1x modulek + 1x zásuvka + USB-C/A

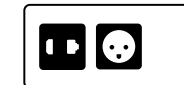

### CRT 4 M2 C+A

2x modulek + 1x zásuvka + USB-C/A



### CRT 4 MS

2x modulek + 2x zásuvka



### MODULKY

POČET MODULKŮ K POUŽITÍ: 1-3



HDMI



HDMI + USB C



HDMI + USB A



USB C



USB A



AUDIO + VGA



LAN



LAN + LAN



HDMI + LAN



USB A + LAN



XLR



BLANK

### CRT 6 2M S

2x modulek + 4x zásuvka

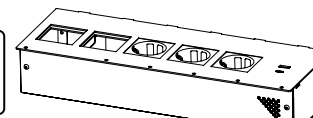
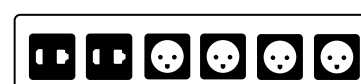

### CRT 6 M 3S

3x modulek + 3x zásuvka

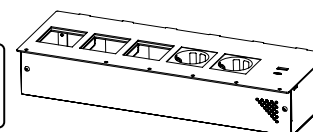

### CRT 6 MS

1x modulek + 5x zásuvka

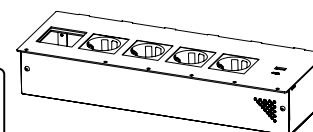
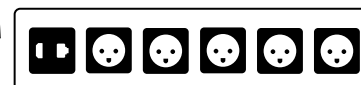

### CRT 6 2M C+A

2x modulek + 3x zásuvka + USB-C/A



### CRT 6 3M C+A

3x modulek + 2x zásuvka + USB-C/A



### CRT 6 M C+A

1x modulek + 4x zásuvka + USB-C/A



### ZDROJOVÝ KABEL

KABEL SE ZÁSTRČKOU



kabel se standardním typem zástrčky a délkou 1,9-4,9 m není dostupný pro všechny světové standardy

WAGO miniWINSTA



25 cm dlouhý pigtail kabel s WINSTA mini plug 2+PE wiring | 10A

WIELAND GST18

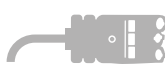

25 cm dlouhý pigtail kabel s GST18i3 plug 2+PE wiring | 10A

# MODULES

by panconnect.

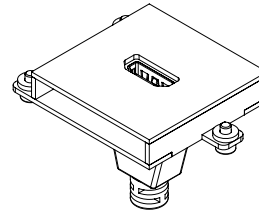

**HDMI**  
**HDMI2.0b**  
F/F  
4K 60HZ  
150mm  
gold plated  
awg32/22  
black pvc

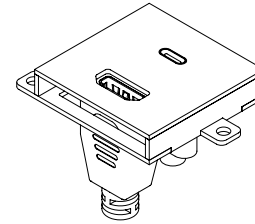

**USB-C 3.2**  
**GEN 2**  
M/F  
10Gbps  
150mm  
gold and nickel plated  
black pvc

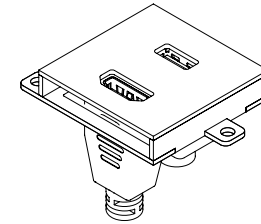

**USB-A 3.0**  
**GEN 2**  
F/F  
5Gbps | 135mm  
gold and nickel plated  
AWG 28/28  
black pvc

**HDMI**  
**HDMI2.0b**  
F/F | 4K 60HZ  
150mm | gold plated  
awg32/22  
black pvc

**HDMI**  
**HDMI2.0b**  
F/F | 4K 60HZ  
150mm | gold plated  
awg32/22  
black pvc

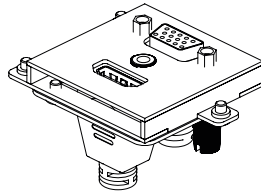

**VGA**  
**DDC2 and EDID support**  
F/F, HD, 150mm  
15pin, black pvc

**AUDIO**  
F/F | 3,5mm jack  
3 PIN 0,35mm  
150mm  
goldplated, black pvc

**HDMI**  
**HDMI2.0b**  
F/F  
4K 60HZ, 150mm  
gold plated, black pvc  
awg32/22

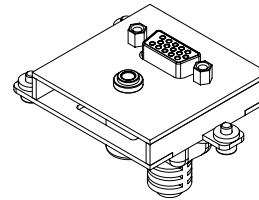

**VGA**  
**DDC2 and EDID support**  
F/F  
HD  
150mm  
15pin  
black pvc

**AUDIO**  
F/F | 3,5mm jack  
3 PIN 0,35mm  
150mm  
goldplated  
black pvc

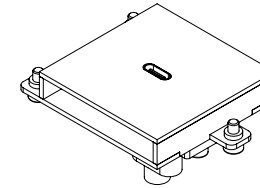

**USB-C 3.2**  
**GEN 2**  
M/F  
10Gbps  
150mm  
gold and nickel plated  
black pvc

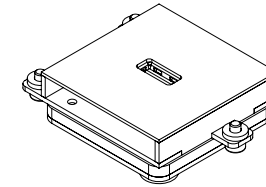

**USB-A 3.0**  
**GEN 2**  
F/F  
5Gbps | 135mm  
gold and nickel plated  
AWG 28/28  
black pvc

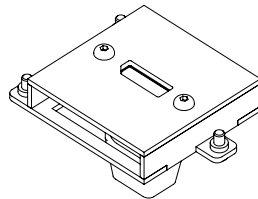

**DISPLAY PORT**  
**DisplayPort 2.0**  
F/F  
4K 60HZ  
150mm  
gold plated  
awg32/22  
black pvc

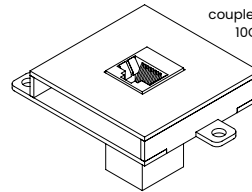

**LAN**  
**CAT 6A**  
coupler RJ45 | up to 500MHz,  
10GBase-T | Gold-plated  
360° shielded  
connection  
Fully shielded  
metal housing

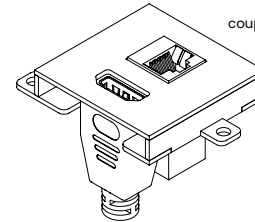

**LAN**  
**CAT 6A**  
coupler RJ45 | up to 500MHz,  
10GBase-T | Gold-plated  
360° shielded  
connection  
Fully shielded  
metal housing

**HDMI**  
**HDMI2.0b**  
F/F | 4K 60HZ  
150mm | gold plated  
awg32/22  
black pvc

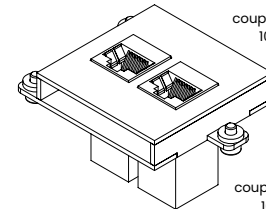

**LAN**  
**CAT 6A**  
coupler RJ45 | up to 500MHz,  
10GBase-T | Gold-plated  
360° shielded  
connection  
Fully shielded  
metal housing

**LAN**  
**CAT 6A**  
coupler RJ45 | up to 500MHz,  
10GBase-T | Gold-plated  
360° shielded  
connection | Fully shielded | metal housing

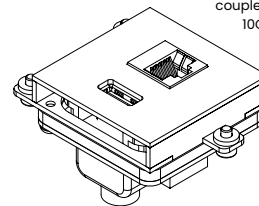

**LAN**  
**CAT 6A**  
coupler RJ45 | up to 500MHz,  
10GBase-T | Gold-plated  
360° shielded  
connection  
Fully shielded  
metal housing

**USB-A 3.0**  
**GEN 2**  
F/F  
5Gbps | 135mm  
gold and nickel plated  
AWG 28/28  
black pvc

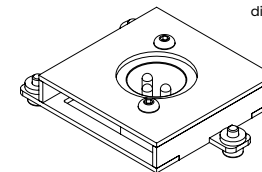

**XLR**  
**SOCKET MALE**  
16 A  
direct 3pin solder-on  
25mm  
nickled  
Black PLA

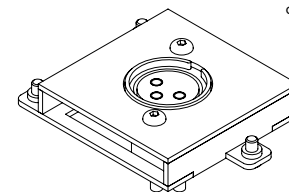

**XLR**  
**SOCKET FEMALE**  
16 A  
direct 3pin solder-on  
25mm  
nickled  
Black PLA

## BAREVNOST



Onyx Black



Cotton White



Alu Silver

## MODULAR

# KABELOVÝ RETRACTOR

by panconnect•

Mechanismus, který umožňuje automatické navíjení až 3 nezávisle na sobě zasouvavých kabelů, pomocí tlačítka s LED indikací. Délka vytažení kabelu je elektronicky hlídána, tak aby maximálně zvyšovala životnost kabelů. **Kabel je možné vytáhnout až na 138 cm.**

## KABELY

### HDMI (M-M)

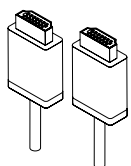

HDMI2.0 | 4K60Hz  
300cm  
gold-plated | AWG32 / 22  
black pvc

### USB 3.0 (M-F)

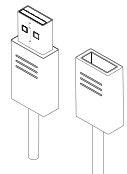

USB3.0 | 5Gbps  
300cm  
9pin  
AWG28/28 | black pvc

### LAN (M-M)

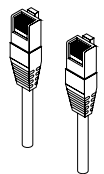

CAT6A RJ45 | UTP  
300cm  
CU 4x2  
AWG26/7 | black pvc

### USB-C 3.2 (M-M)

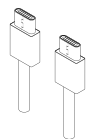

USB-C 3.2 gen 1  
10Gbps | 300cm  
gold and nickel plated  
black pvc

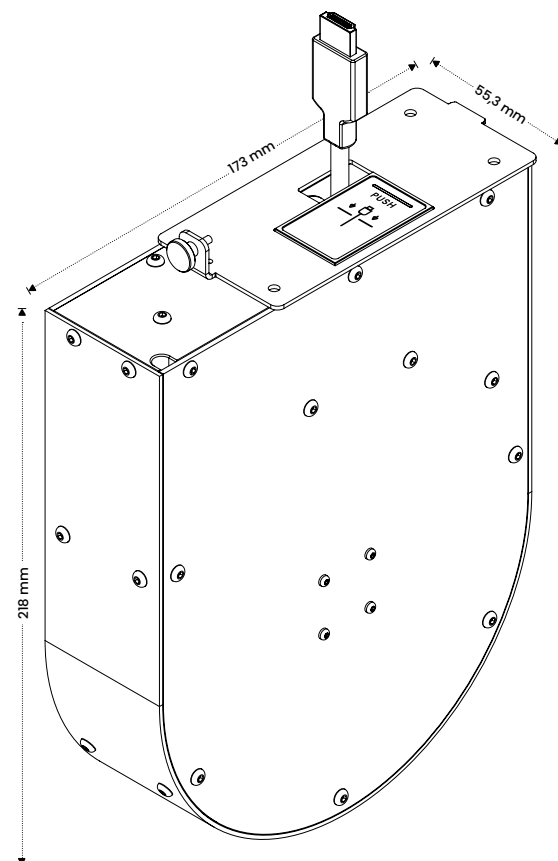

1250 g

## CO NALEZNETE V BALENÍ ?

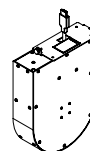

Kabelový RETRACTOR

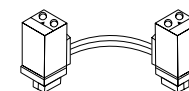

1 × kabel na propojení

MODULAR

# KABELOVÝ RETRACTOR

by panconnect•

## KABELOVÝ RETRACTOR A KRYCÍ PLECH

PRO 1  
KABELOVÝ  
RETRACTOR

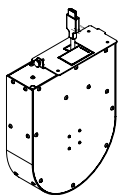

PRO 2  
KABELOVÉ  
RETRACTORY

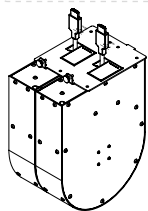

PRO 3  
KABELOVÉ  
RETRACTORY

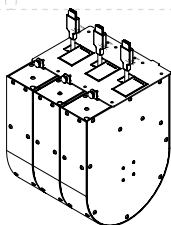

## BAREVNOST



Onyx Black



Cotton White



Alu Silver

1|

Vytáhněte až **138 cm** kabelu. Integrovaný **pull-back** systém hlídá délku vytažení a motorická brzda **brání přetažení kabelu**.

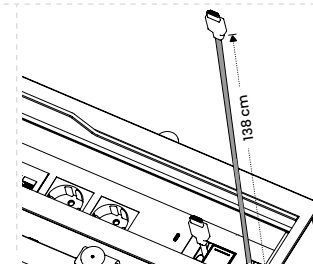

2|

**Ukládejte kabely** po jednání pohodlně a bezpečně, stiskem jednoho tlačítka. **"Safe mode"** zajistí vypnutí navíjení kabelu v případě, že se zasekne o hranu stolu nebo věci na stole.

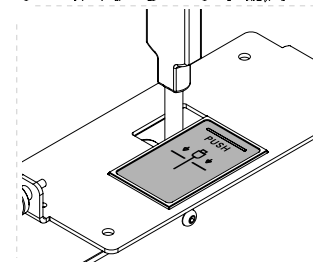

3|

Díky kompaktním rozměrům nezabírá pod stolem mnoho místa. **"Silent running"** zařízení vhodné pro použití v pracovním prostředí.

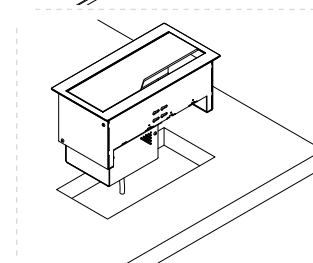

4|

Zařízení **komunikuje o svém stavu** s uživatelem pomocí **barevných signálů**. Poznáte tedy, kdy je připraveno k použití, kdy se kabel navíjí apod.

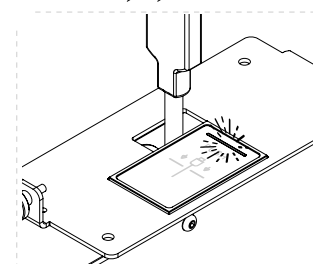

5|

**Napájení jednotek kabelového RETRACTORU**

Pro napájení kabelového RE-TRACTORU je potřeba připojit externí zdroj. Externí zdroj není součástí balení. Pro 1-3 RETRACTORY stačí 1 externí zdroj.

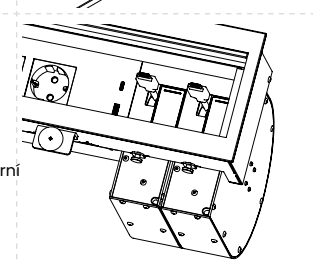



# PULL-OUT SYSTEM

by panconnect•

Mechanismus, který umožňuje zasouvání až 6ti nezávisle na sobě zasouváných kabelů pomocí závaží do designovaného vaku umístěného pod stolem. **Maximální délka vytažení kabelu je 96 cm.**

## ZÁVAŽÍ

SIZE S

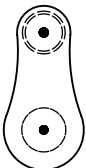

SIZE M

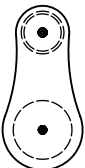

SIZE L

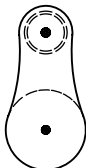

váha od 230g do 464 g dle typu kabelů

## TYPY PULL-OUT PRO UNI

2 KABELOVÝ SYSTÉM

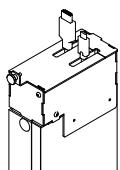

1700 g

4 KABELOVÝ SYSTÉM

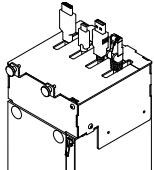

2600 g

6 KABELOVÝ SYSTÉM

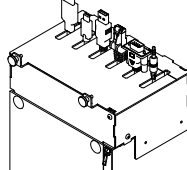

5000 g

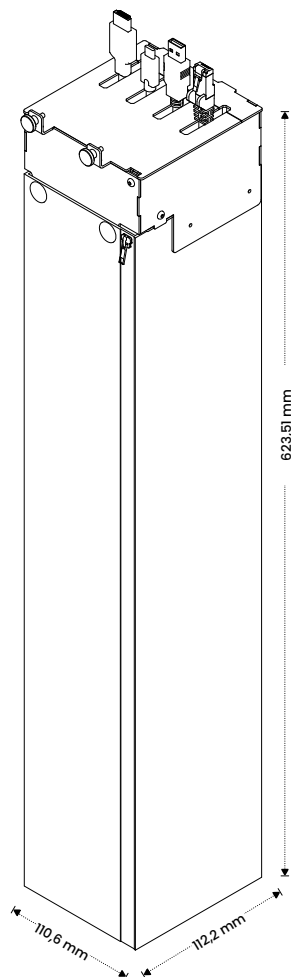

## CO NALEZNETE V BALENÍ ?

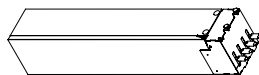

1 x pull-out system

## KABELY

POČET KABELŮ K POUŽITÍ: 2-6

USB-C 3.2 (M-M)

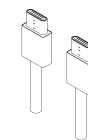

USB-C 3.2 gen 1  
5Gbps | 200cm  
gold and nickel plated  
black pvc

USB-C 3.2 (M-F)

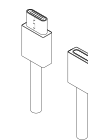

USB-C 3.2 gen 1  
5Gbps | 200cm  
gold and nickel plated  
black pvc

USB-C (M) / HDMI (M)

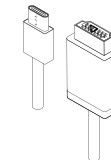

HDMI2.0 | 4K60Hz  
200cm  
gold-plated  
AWG32 / 22 | black pvc

mini DISPLAY PORT (M) / HDMI (M)

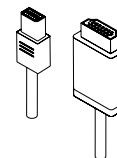

DP | 4K30Hz  
200cm  
4K/UHD/2160p@60Hz  
black pvc

DISPLAY PORT (M-M)

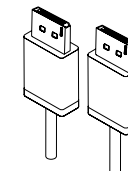

DPI.4 | 8K60Hz  
200cm  
gold-plated  
AWG32 / 22 | black pvc

DISPLAY PORT (M) / HDMI (M)

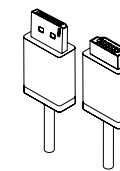

2K DP | WUXGA (1920x1200)  
200cm  
SECURE LOCK | gold-plated  
AWG28 | black pvc

HDMI (M-M)

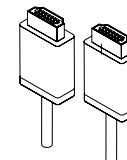

HDMI1.4 | 4K30Hz  
200cm  
gold-plated | AWG32 / 22  
black pvc

HDMI (M-F)

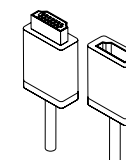

HDMI1.4 | 4K30Hz  
200cm  
gold-plated | AWG32 / 22  
black pvc

VGA (M-M)

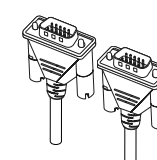

VGA | HD  
180cm | 15pin  
DDC2 and EDID support  
black pvc

LAN (M-M)

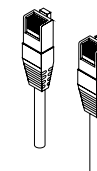

CAT6 RJ45 | UTP  
200cm  
CU 4x2  
AWG26/7 | black pvc

USB 3.0 (M-F)

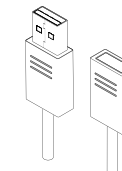

USB3.0 | 5Gbps  
200cm  
9pin  
AWG28/28 | black pvc

AUDIO (M-F)

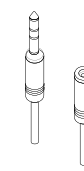

200cm  
goldplated  
black pvc

# BEZPEČNOST & RECYKLACE



PANCONNECT tímto prohlašuje, že přípojný panel UNI vyhovuje směrnici o nízkém napětí (2014/35/EU) a také směrnici o Elektromagnetické kompatibilitě (2014/30 EU). Testování bylo provedeno dle norem EN 50491-5-1:2010, EN 50491-5-2:2010.



Produkty PANCONNECT jsou v souladu s politikou společnosti určeny k **upgradu**, nejlépe pak maximální **recyklaci**.



Než přistoupíte k likvidaci, ověřte si u nás, zda-li je možné produkt upgradovat nebo repasovat. Pokud to není možné zajistěte jeho likvidaci dle platných směrnic. Produkt spadá do skupiny ODPAD Z ELEKTRONICKÝCH ZAŘÍZENÍ, jeho likvidace je možná pouze v souladu s evropskou směrnicí 2012/19/EU a nelze jej likvidovat společně s komunálním odpadem.  
[www.asekol.cz](http://www.asekol.cz) | [info@asekol.cz](mailto:info@asekol.cz)

## INSTRUKCE K INSTALACI

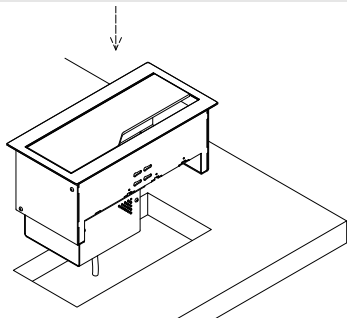

**Potřebujete: imbusový klíč, přímočará pila, vrtačka**

**01** Podle velikosti panelu naznačte rozměr otvoru a vyvrtejte v protilehlých rozích dva otvory uvnitř rámečku

**02** Přímočarou pilou vyřízněte obvod naznačeného tvaru

**03** Zasadte panel kabelem napřed a nasadte úchyt do drážek panelů.

Pomocí imbusového klíče č. 3 dotáhněte úchyt.

MODULAR

### USB-C SPECIFIKACE

PowerDelivery up to 60W

### USB-A SPECIFIKACE

QuickCharge 3.0 up to 5A

### SPECIFIKACE ZÁSUVK

230V/10A (EU), 110V/10A (US)

### OCHRANA PROTI VNIKNUTÍ

IP22

### ELEKTRICKÉ SPECIFIKACE VSTUPNÍ

110 - 250V, 10A

### MODULARITA

MODULES (2021) | PULL-OUT | RETRACTOR

### MATERIÁLY

Dural | nerezová ocel | FENIX NTM | kortexin

### DESIGNER

Dominik Hutečka

Navrženo a vyrobeno v Brně, Česká republika.

PANCONNECT s.r.o. | Olomoucká 51, Brno | Czech Republic  
[www.panconnect.eu](http://www.panconnect.eu) | [support@panconnect.eu](mailto:support@panconnect.eu)

panconnect.