

UNI

by panconnect.

UNI - name of this product speaks for itself. PANCONNECT'S **most universal product** offers many configuration options either for complex audio-video projects or easy design connectivity on working places, conference tables and conference rooms. You can choose from 3 different colour variants.

Two sizes of panel UNI are available - **UNI4** and **UNI6**. PANCONNECT offers several **CARTRIDGE** options that can be fitted to both variants of UNI. Cartridges contain a power socket part and alternatively USB-A and USB-C (60 W) charging. Cartridges with sockets are always part of the panel. Connector module and pull out system is optional. There is a possibility to use only cartridges with sockets and modules for the whole width of model UNI4. Panel UNI enables

integration of control system using a special dual modul.

You can choose from 2 mechanisms for effective manipulation with cables - **CABLE RETRACTOR** and **PULL-OUT**. PULL-OUT system works on the principle of gravity weighted cables in a textile bag and it allows the cable to be pulled up **to 96 cm** (the total length of the cable is 200 cm). It is produced in 2, 4 or 6 cable variants where 2 cables take 1 position in the panel. CABLE RETRACTOR is an automatic cable retracting system that allows pulling out the cable **up to 138 cm** (total length of the cable is 300 cm). It includes smart electronics that maximize the easiness of the cable pull out and the cable is automatically retracted when the button is pushed.

DIMENSIONS	WEIGHT	MAX. NUMBER OF SOCKETS	MAX. NUMBER OF MODULES	PULL-OUT CABLE SYSTEM	DIMENSIONS WITH PULL-OUT CABLE SYSTEM	CABLE RETRACTOR	ADAPTER FOR CONTROL SYSTEM
------------	--------	------------------------	------------------------	-----------------------	---------------------------------------	-----------------	----------------------------

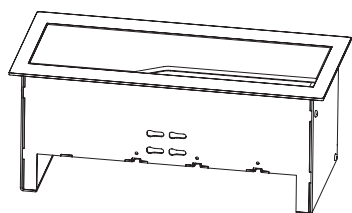

UNI 4

282 × 124 × 112 mm	4910 g	4	2	up to 4	282 × 124 × 700 mm	up to 2	BIAMP Needs Cue
--------------------	--------	---	---	---------	--------------------	---------	-------------------

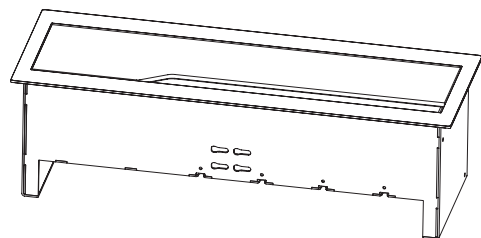

UNI 6

390,8 × 124 × 112 mm	6100 g	6	3	up to 6	390,8 × 124 × 700 mm	up to 3	BIAMP Needs Cue
----------------------	--------	---	---	---------	----------------------	---------	-------------------

HOW TO ASSEMBLE UNI IN 4 STEPS

VISIT
PANCONNECT.EXPIVI.NET
FOR EASY ONLINE
CONFIGURATION



1| CHOOSE SIZE, COLOUR
AND SHAPE OF THE CHASSIS
(OPTIONALLY THE CONTROL SYS-
TEM)



2| CHOOSE RELEVANT CARTRIDGE
FOR YOUR PANEL



3| ADD RETRACTING CABLE
SYSTEM FOR YOUR PANEL



4| CHOOSE PREFERRED POWER
CABLE

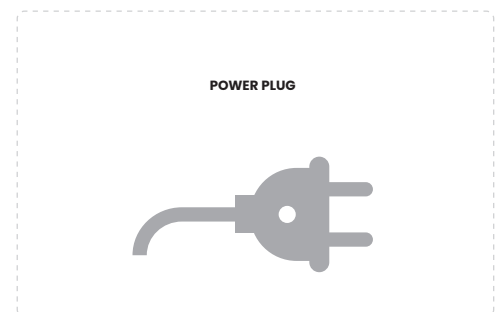
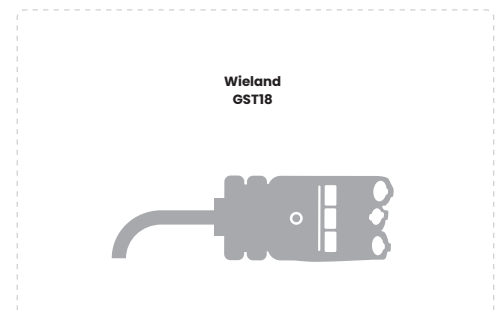
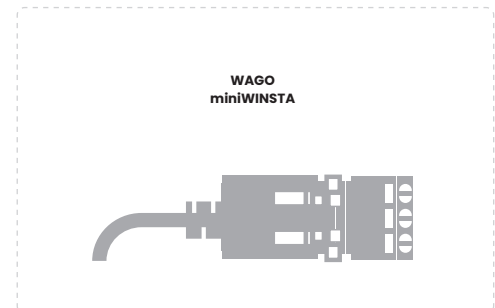
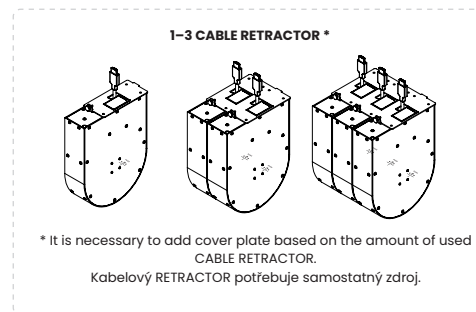
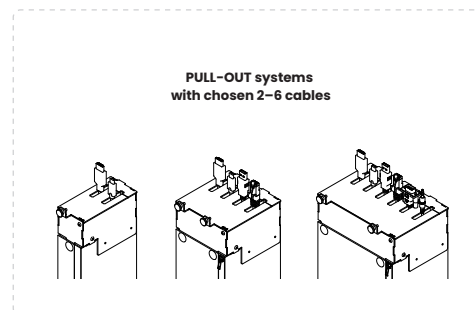
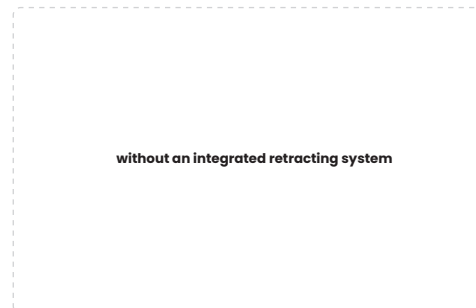
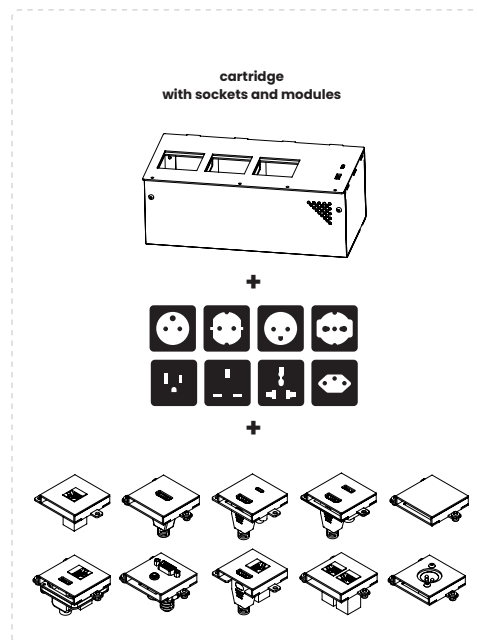
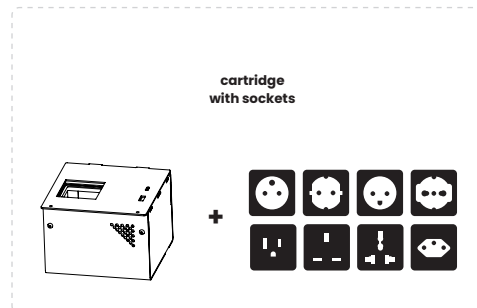
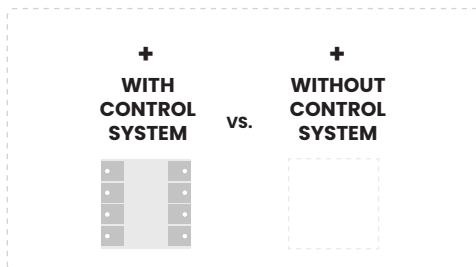
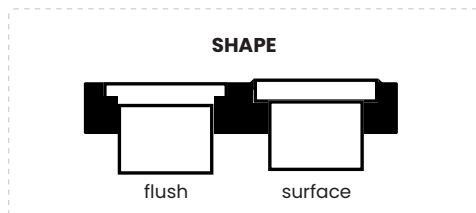
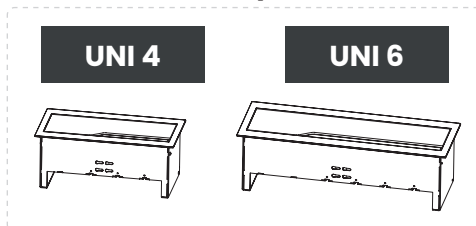

UNI

by panconnect•

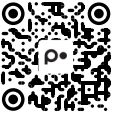

UNI 4



3012 g

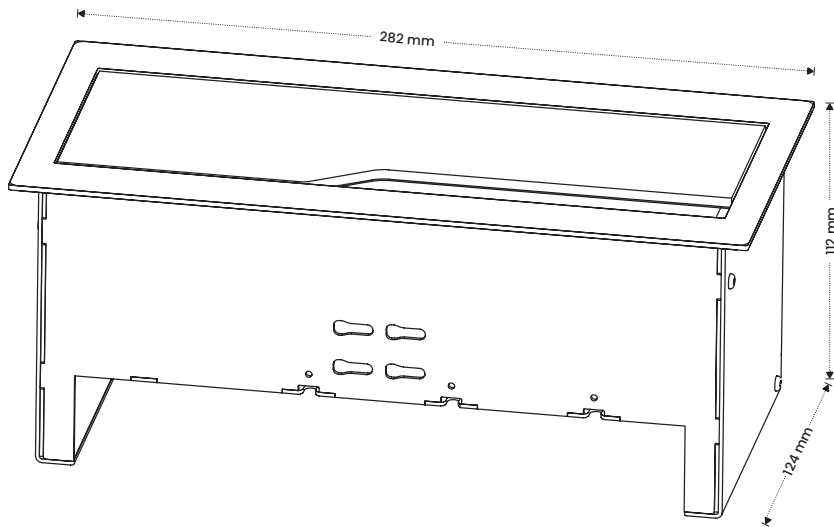

UNI 6



3800 g

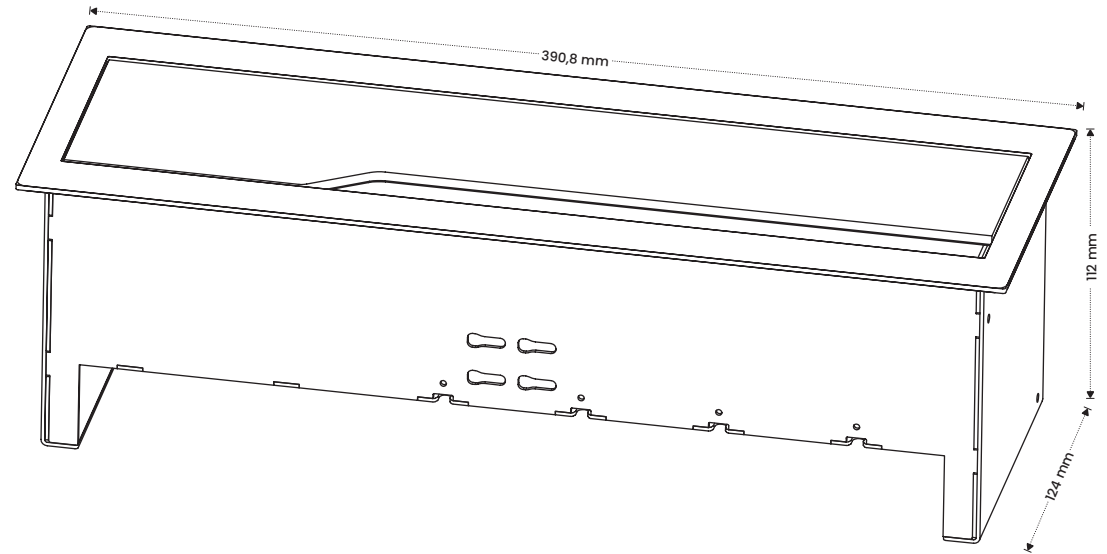

COLOURS



Onyx Black



Cotton White



Alu Silver

CONTROL SYSTEM

BIAMP NEEDS



ready for easy installation of standard 55 x 55 mm control system from Biamp/Neets (BraVo, OsCar, Echo, Sierra)

CUE



ready for installation of small wired 8-button keypad CUE-55 from CUE systems

OWN INTEGRATION



other control system up to 55 x 55 mm size supported. For more information please contact your sales rep.

WHAT IS INCLUDED IN THE PACKAGE ?

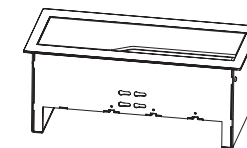

1x chassis

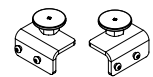

2 x table mounts

MODULAR

CARTRIDGE

WITHOUT MODULES

by panconnect•

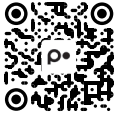

COLOURS



Onyx Black



Cotton White



Alu Silver

SOCKETS

NUMBER OF SOCKETS: 1-6



FR



SC



DK



IT



US



UK



UN



CH

POWER CABLES

POWER PLUG



cable with standard plug type a
cable length 1,9 to 4,9m) -
not available for all standards

WAGO miniWINSTA



25 cm long pigtail
cable with WINSTA mini plug
2+PE wiring | 10A

WIELAND GST18

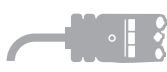

25 cm long pigtail
cable with GST1813 plug
2+PE wiring | 10A

CRT 2 S

2× sockets

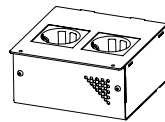
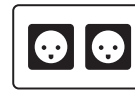

CRT 3 C+A

2× socket + USB-C/A

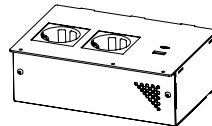

CRT 4 C+A

3× socket + USB-C/A

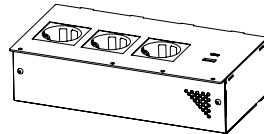

CRT 6 C/A

5× socket + USB-C/A

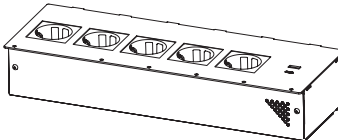

CRT 6 S

6× socket

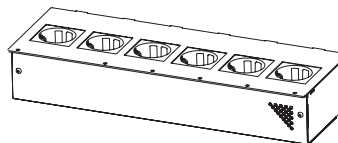

CRT 2 C+A

1× socket + USB-C/A

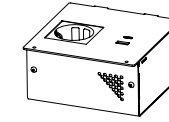

CRT 3 S

3× socket

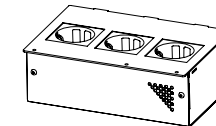

CRT 4 S

4× socket

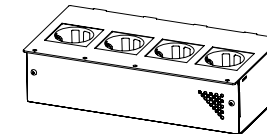

CARTRIDGE

WITH MODULES

by panconnect•



COLOURS



Onyx Black



Cotton White



Alu Silver

SOCKETS

NUMBER OF SOCKETS: 1-5



FR



SC



DK



IT



US



UK



UN



CH

MODULES

NUMBER OF MODULES: 1-3



HDMI



HDMI + USB C



HDMI + USB A



USB C



USB A



AUDIO + VGA



LAN



LAN + LAN



HDMI + LAN



USB A + LAN



XLR



BLANK

POWER CABLES

POWER PLUG



cable with standard plug type a cable length 1,9 to 4,9m) - not available for all standards

WAGO miniWINSTA



25 cm long pigtail cable with WINSTA mini plug 2+PE wiring | 10A

WIELAND GST18



25 cm long pigtail cable with GST1813 plug 2+PE wiring | 10A

CRT 3 MS

1x module + 2x socket

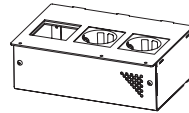

CRT 4 M C+A

1x module + 2x socket + USB-C/A

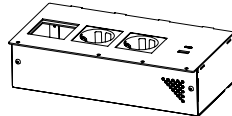

CRT 4 MS

1x module + 3x socket

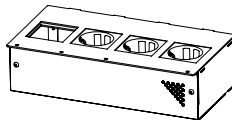

CRT 6 2M S

2x module + 4x socket

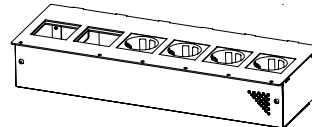
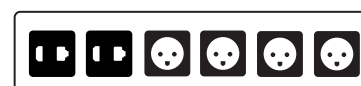

CRT 6 M 3S

3x module + 3x socket

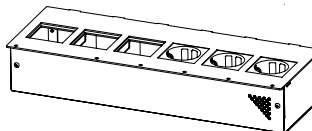

CRT 6 MS

1x module + 5x socket

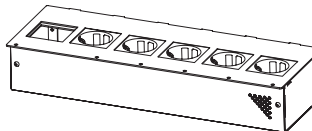

CRT 3 M C+A

1x module + 1x socket + USB-C/A

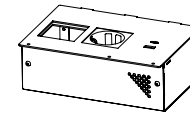

CRT 4 M2 C+A

2x module + 1x socket + USB-C/A

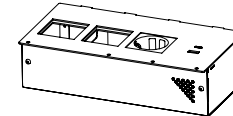

CRT 4 MS

2x module + 2x socket

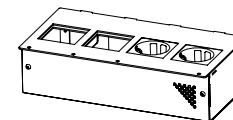

CRT 6 2M C+A

2x module + 3x socket + USB-C/A

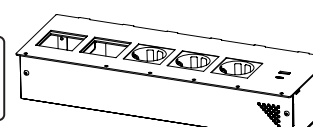

CRT 6 3M C+A

3x module + 2x socket + USB-C/A

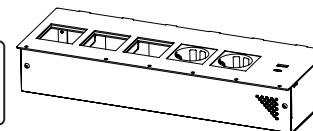

CRT 6 M C+A

1x module + 4x socket + USB-C/A

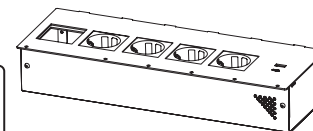

MODULES

by panconnect.

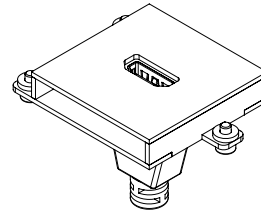

HDMI
HDMI2.0b
F/F
4K 60HZ
150mm
gold plated
awg32/22
black pvc

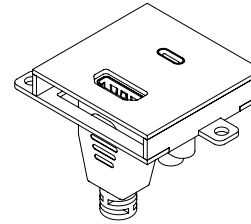

USB-C 3.2
GEN 2

M/F
10Gbps
150mm
gold and nickel
plated
black pvc

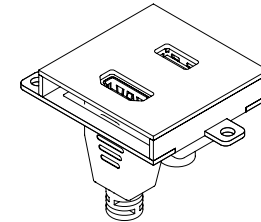

USB-A 3.0
GEN 2

F/F
5Gbps | 135mm
gold and nickel plated
AWG 28/28
black pvc

HDMI
HDMI2.0b
F/F | 4K 60HZ
150mm | gold plated
awg32/22
black pvc

HDMI
HDMI2.0b
F/F | 4K 60HZ
150mm | gold plated
awg32/22
black pvc

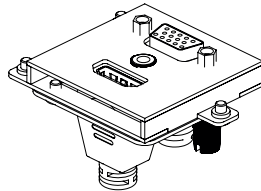

VGA
DDC2 and EDID support
F/F, HD, 150mm
15pin, black pvc

AUDIO
F/F | 3,5mm jack
3 PIN 0,35mm
150mm
goldplated, black pvc

HDMI
HDMI2.0b
F/F
4K 60HZ, 150mm
gold plated, black pvc
awg32/22

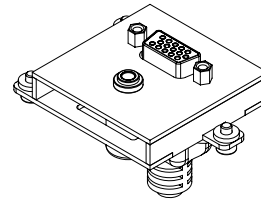

VGA
DDC2 and EDID support

F/F
HD
150mm
15pin
black pvc

AUDIO
F/F | 3,5mm jack
3 PIN 0,35mm
150mm
goldplated
black pvc

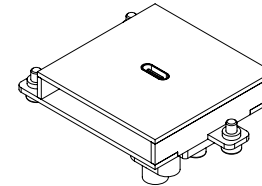

USB-C 3.2
GEN 2

M/F
10Gbps
150mm
gold and nickel plated
black pvc

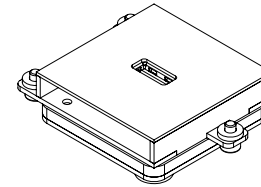

USB-A 3.0
GEN 2

F/F
5Gbps | 135mm
gold and nickel plated
AWG 28/28
black pvc

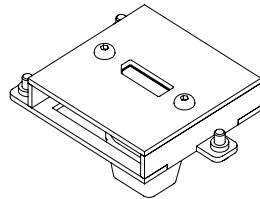

DISPLAY PORT
DisplayPort 2.0

F/F
4K 60HZ
150mm
gold plated
awg32/22
black pvc

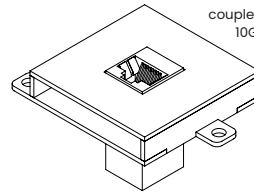

LAN
CAT 6A

coupler RJ45 | up to 500MHz,
10GBase-T | Gold-plated
360° shielded
connection
Fully shielded
metal housing

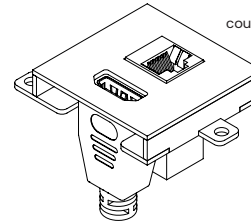

LAN
CAT 6A

coupler RJ45 | up to 500MHz,
10GBase-T | Gold-plated
360° shielded
connection
Fully shielded
metal housing

HDMI
HDMI2.0b
F/F | 4K 60HZ
150mm | gold plated
awg32/22
black pvc

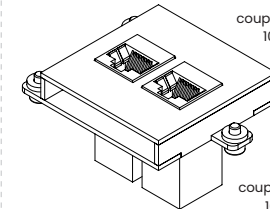

LAN
CAT 6A

coupler RJ45 | up to 500MHz,
10GBase-T | Gold-plated
360° shielded
connection
Fully shielded
metal housing

LAN
CAT 6A
coupler RJ45 | up to 500MHz,
10GBase-T | Gold-plated
360° shielded
connection | Fully shielded | metal housing

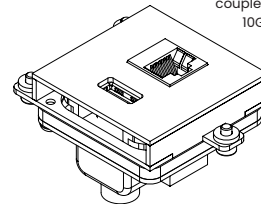

LAN
CAT 6A

coupler RJ45 | up to 500MHz,
10GBase-T | Gold-plated
360° shielded
connection
Fully shielded
metal housing

USB-A 3.0
GEN 2

F/F
5Gbps | 135mm
gold and nickel plated
AWG 28/28
black pvc

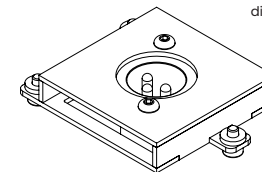

XLR
SOCKET MALE

16 A
direct 3pin solder-on
25mm
nickled
Black PLA

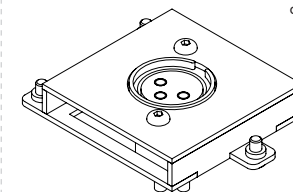

XLR
SOCKET FEMALE

16 A
direct 3pin solder-on
25mm
nickled
Black PLA

COLOURS



Onyx Black



Cotton White



Alu Silver

MODULAR

CABLE RETRACTOR

by panconnect•

A mechanism that allows automatic cable retraction up to 3 independent cables using a button with LED indication. Length of the pull out cable is electronically guarded so that it maximally increases the lifetime of the cable. Cable can be pulled out up to 138 cm.

CABLES

HDMI (M-M)

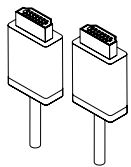

HDMI2.0 | 4K60Hz
200cm
gold-plated | AWG32 / 22
black pvc

USB 3.0 (M-F)

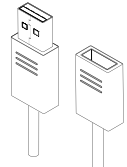

USB3.0 | 5Gbps
200cm
9pin
AWG28/28 | black pvc

LAN (M-M)

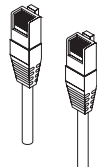

CAT6A RJ45 | UTP
200cm
CU 4x2
AWG26/7 | black pvc

USB-C 3.2 (M-M)

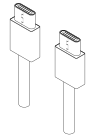

USB-C 3.2 gen 1
5Gbps | 200cm
gold and nickel plated
black pvc

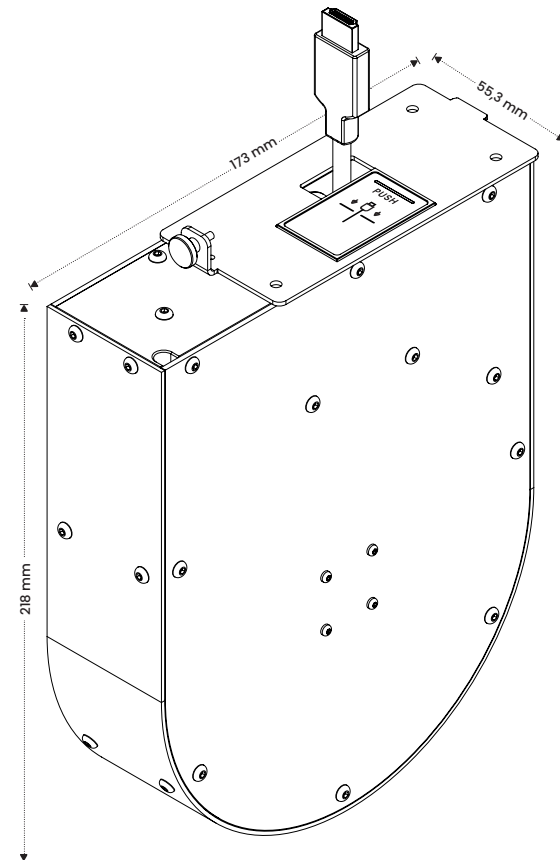

1250 g

WHAT IS INCLUDED IN THE PACKAGE?

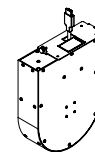

CABLE RETRACTOR

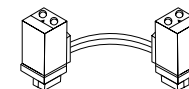

1 × connection cable

MODULAR

CABLE RETRACTOR

by panconnect•

CABLE RETRACTOR AND COVER PLATE

FOR 1
CABLE
RETRACTOR

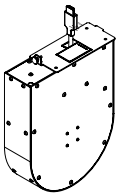

FOR 2
CABLE
RETRACTORS

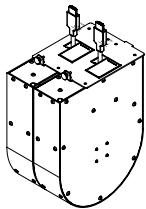

FOR 3
CABLE
RETRACTORS

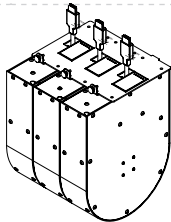

COLOURS



Onyx Black



Cotton White



Alu Silver

1|

You can pull out the cable up to 138 cm. There is an integrated system that guards the length of the pull out and there is also a motor brake that prevents cable from dragging.

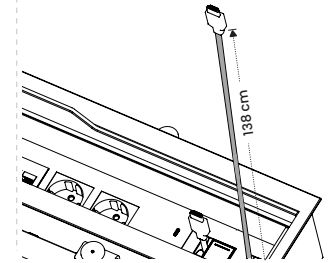

2|

Tidy cables away comfortably and safely by pushing one button. "Safe mode" enables the switch off of the cable retracting in case of a stuck cable on the edge of the table or in case of objects **on the table**.

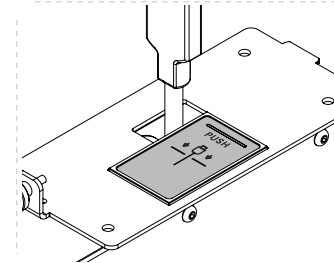

3|

Due to the compact size of the panel, it doesn't take that much space under the table. "Silent running" is suitable for work environment usage.

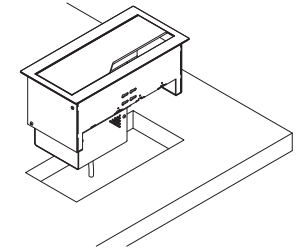

4|

Cable RETRACTOR communicates with the user about the status by colour signals. The user then easily recognizes when the RETARCTOR is ready to be used, when the cable is retracting etc.

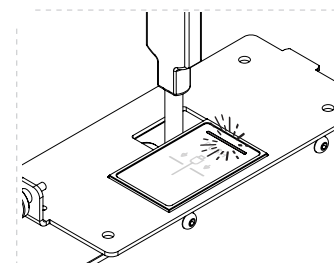

5|

External power supply is needed for charging of the cable RETRACTOR.

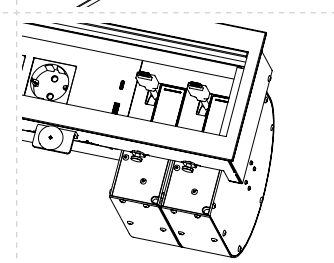

PULL-OUT SYSTEM

by panconnect•

PULL- OUT system is a mechanism that enables retraction of up to 6 independent cables to a designed bag placed under the table using weight. Maximum length of the pull out cable is 96 cm.

WEIGHT

SIZE S

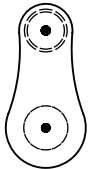

weight from 230g to 464 g depending on the type of the cable

SIZE M

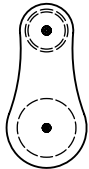

SIZE L

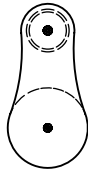

PULL-OUT OPTIONS FOR UNI

2- CABLE SYSTEM

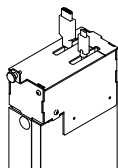

710 g

4- CABLE SYSTEM

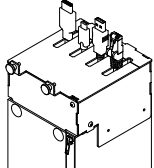

1096 g

6- CABLE SYSTEM

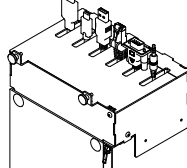

1452 g

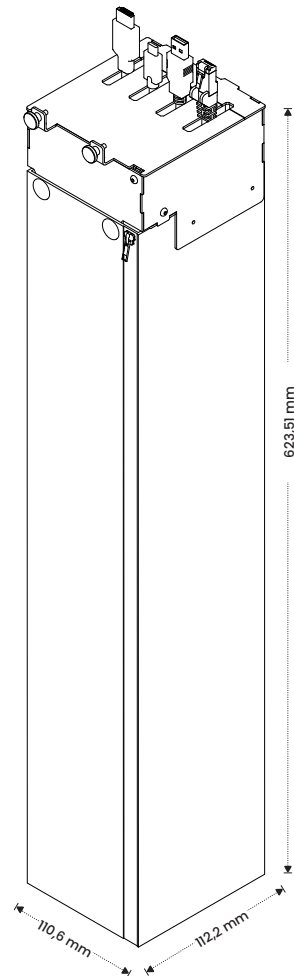

WHAT IS INCLUDED IN THE PACKAGE?

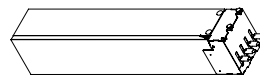

1 × selected PULL-OUT system

CABLES

NUMBER OF CABLES: 2-6

USB-C 3.2 (M-M)

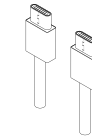

USB-C 3.2 gen 1
5Gbps | 200cm
gold and nickel plated
black pvc

USB-C 3.2 (M-F)

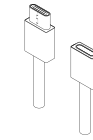

USB-C 3.2 gen 1
5Gbps | 200cm
gold and nickel plated
black pvc

USB-C (M) / HDMI (M)

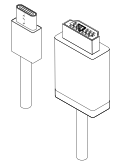

HDMI2.0 | 4K60Hz
200cm
gold-plated
AWG32 / 22 | black pvc

mini DISPLAY PORT (M) / HDMI (M)

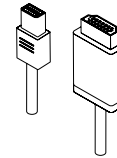

DP | 4K30Hz
200cm
4K/UHD/2160p@60Hz
black pvc

DISPLAY PORT (M)

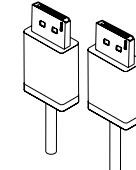

DPI.4 | 8K60Hz
200cm
gold-plated
AWG32 / 22 | black pvc

DISPLAY PORT (M) / HDMI (M)

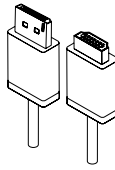

2K DP | WUXGA (1920x1200)
200cm
SECURE LOCK | gold-plated
AWG28 | black pvc

HDMI (M-M)

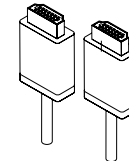

HDMI1.4 | 4K30Hz
200cm
gold-plated | AWG32 / 22
black pvc

HDMI (M-F)

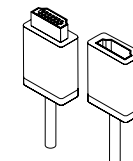

HDMI1.4 | 4K30Hz
200cm
gold-plated | AWG32 / 22
black pvc

VGA (M-M)

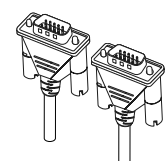

VGA | HD
180cm | 15pin
DDC2 and EDID support
black pvc

LAN (M-M)

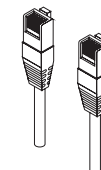

CAT6 RJ45 | UTP
200cm
CU 4x2
AWG26/7 | black pvc

USB 3.0 (M-F)

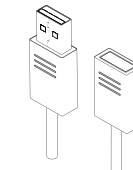

USB3.0 | 5Gbps
200cm
9pin
AWG28/28 | black pvc

AUDIO (M-F)

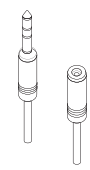

200cm
goldplated
black pvc

SAFETY & RECYCLATION



PANCONNECT declares that panel UNI complies with Low voltage directive 2014/35/EC and EMC directive 2014/30/EU. Testing has been made according to EN 50491-5-1:2010 and EN 50491-5-2:2010 standards.



All products from PANCONNECT are intended for upgrade or recycling in accordance with the company's policy.



Before the disposal of this panel comes up, please verify if this product can or cannot be upgraded or overhauled. If it's not possible, kindly arrange the disposal in accordance with valid EU directives. This product belongs to WASTE ELECTRICAL AND ELECTRONIC EQUIPMENT (WEEE) category so the disposal is possible only in accordance with this WEEE Directive 2012/19/EU. It cannot be part of the municipal waste. For more information please check www.asekol.cz | info@asekol.cz

INSTALLATION MANUAL

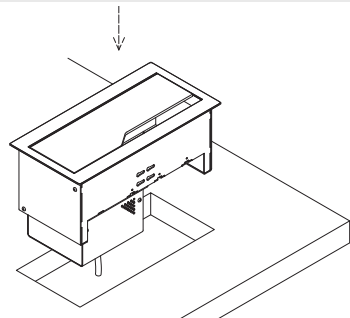

Tools: hex key, drill, jig saw

01 Based on the size of the panel, mark size of the hole and drill two holes in the opposite corners inside of the frame

02 Take the jigsaw and cut the perimeter of the given shape

03 Put the panel to the hole and place the clip to the panel's groove.

Tighten the clip using a hex key no.3.

MODULAR

USB-C SPECIFICATION

PowerDelivery up to 60W

USB-A SPECIFICATION

QuickCharge 3.0 up to 5A

SOCKETS

230V/10A (EU), 110V/10A (US)

INGRESS PROTECTION

IP22

POWER SUPPLY

110 - 250V, 10A

MODULARITY

MODULES (2021) | PULL-OUT | RETRACTOR

MATERIALS

Dural | stainless steel | FENIX NTM | kortexin

DESIGNER

Dominik Hutečka

Designed & manufactured in Brno, Czech republic.

PANCONNECT s.r.o. | Olomoucká 51, Brno | Czech Republic
www.panconnect.eu | support@panconnect.eu

panconnect