

FLAT

by panconnect•

FLAT is a basic but very universal panel that can be placed on working places, conference tables, and in conference rooms. This product can be used practically everywhere where universal connectivity plays a role. When there is a requirement for maximum modularity, low installation depth and easy installation, **FLAT** is the right choice.

PANCONNECT offers 5 variants of this product.

FLAT BASIC contains only sockets and connection modules, alternatively pull-out or pass-thru module. Three

other sizes - **FLAT M, L** and **XL** can be used depending on the connectivity requirements and number of sockets that are needed. All the panels include **USB - A and USB - C** (60W) charging slots, alternatively Qi charging that is integrated directly in the panel.

FLAT PLUS includes on top of that third party's active module (for size from 45 to 55 mm), typically a control compact system or active signal element.

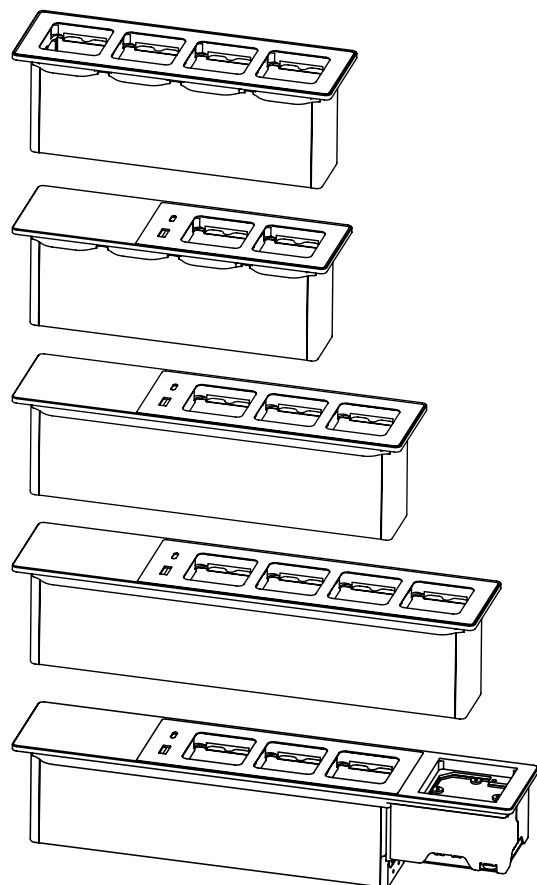

	DIMENSION	WEIGHT	MAX. NUMBER OF SOCKETS	MAX. NUMBER OF MODULES	POSSIBILITY OF Qi WIRELESS CHARGING	ADAPTER FOR CONTROL SYSTEM	DIMENSION WITH PULL-OUT CABLE SYSTEM
BASIC	227,5 × 73 × 81 mm	760 g	4	2	×	×	227,5 × 73 × 690 mm
M	227,5 × 73 × 81 mm	1150 g	2	1	✓	×	227,5 × 73 × 690 mm
L	279 × 73 × 81 mm	1260 g	3	2	✓	×	279 × 73 × 690 mm
XL	330,5 × 73 × 81 mm	1370 g	4	3	✓	×	330,5 × 73 × 690 mm
PLUS	360 × 73 × 81 mm	1740 g	3	2	✓	NEETS CUE	360 × 73 × 690 mm

FLAT

by panconnect.

BASIC

SOCKETS

NUMBER OF SOCKETS: 2-4

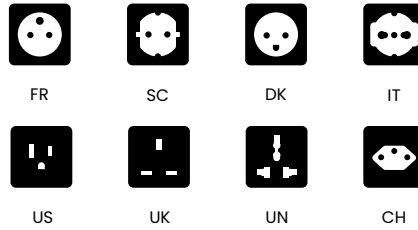

MODULES

NUMBER OF MODULES: 0-2

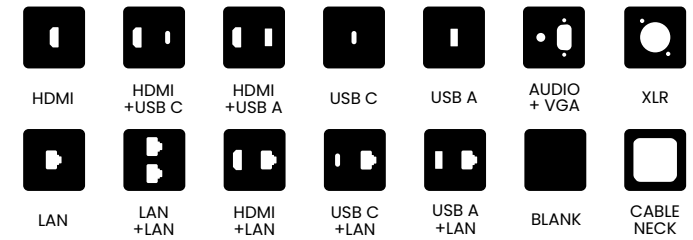

760 g

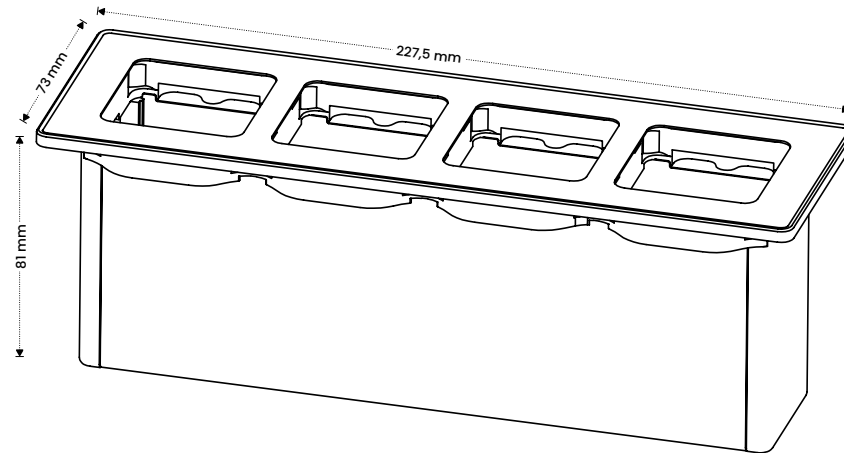

COLOURS



black



white



silver

POWER CABLES

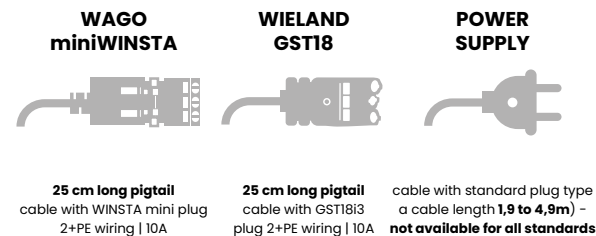

PACKAGE CONTAINS

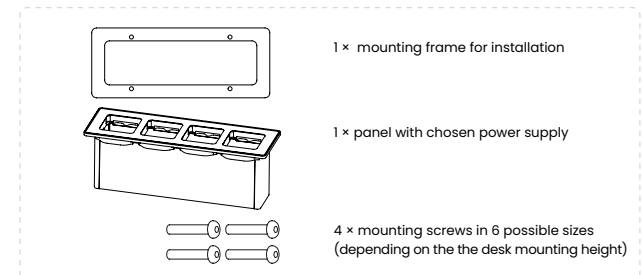

FLAT

by panconnect•

SIZE M

SOCKETS

NUMBER OF SOCKETS: 1-2

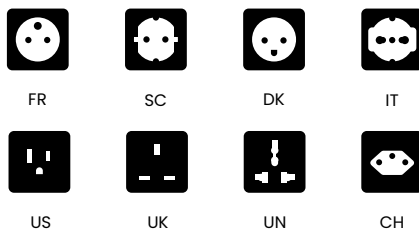

MODULES

NUMBER OF MODULES: 0-1

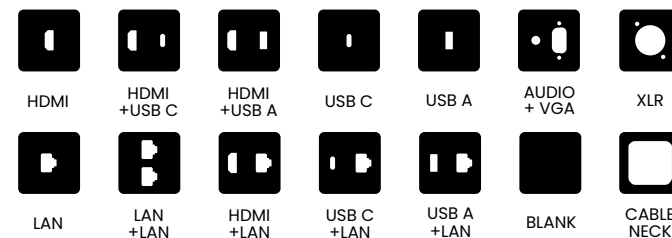

1150 g

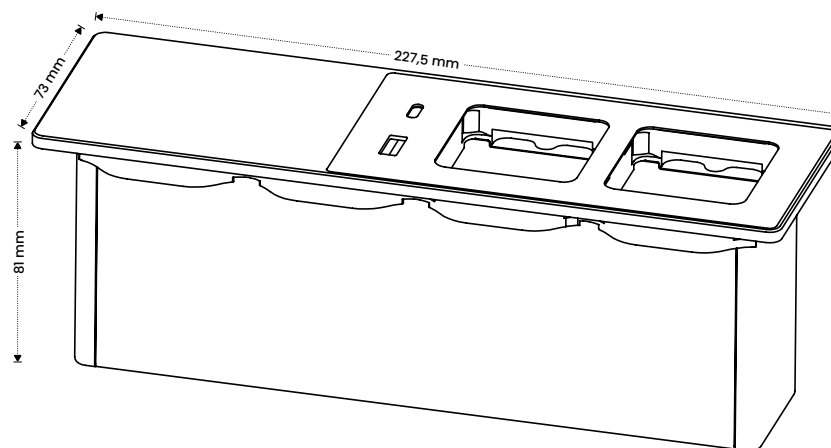

COLOURS



black



white



silver

WIRELESS CHARGING

Qi compliant 1.5A/5V

WITH INTEGRATED Qi

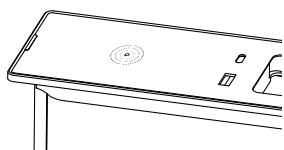

WITHOUT INTEGRATED Qi

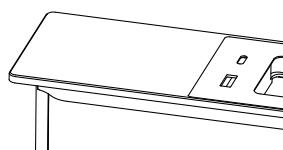

POWER CABLES

WAGO miniWINSTA



25 cm dlouhý pigtail
kabel s WINSTA mini plug
2+PE wiring | 10A

WIELAND GST18



25 cm dlouhý pigtail
kabel s GST183 plug
2+PE wiring | 10A

POWER SUPPLY



cable with standard plug type
a cable length 1,9 to 4,9m) -
not available for all standards

PACKAGE CONTAINS

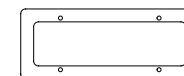

1 × mounting frame for installation

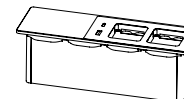

1 × panel with chosen power supply

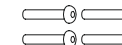

4 × mounting screws in 6 possible sizes
(depending on the the desk mounting height)



FLAT

by panconnect.

SIZE L

SOCKETS

NUMBER OF SOCKETS: 1-3

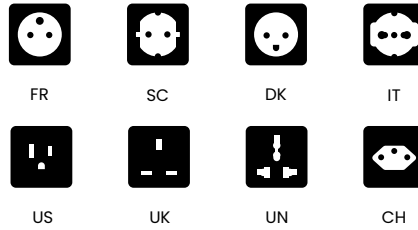

MODULES

NUMBER OF MODULES: 0-2

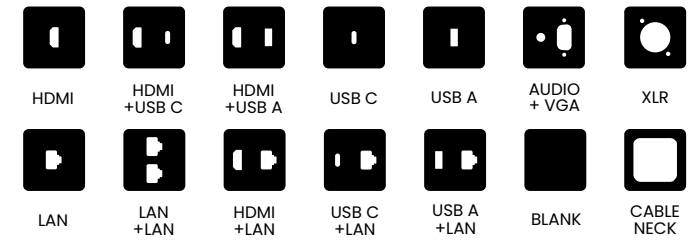

1260 g

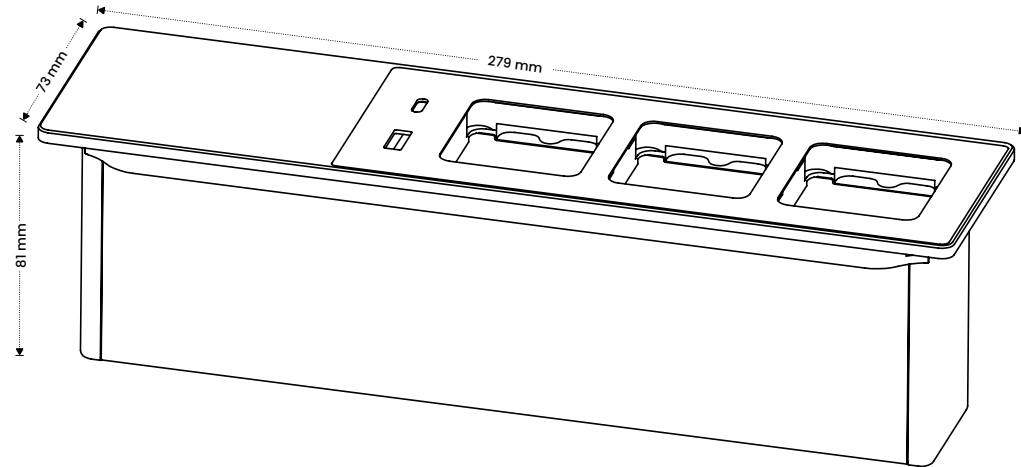

COLOURS



black



white



silver

WIRELESS CHARGING

Qi compliant 1.5A/5V

WITH INTEGRATED Qi

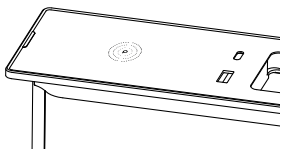

WITHOUT INTEGRATED Qi

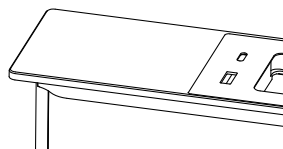

POWER CABLES

WAGO miniWINSTA



25 cm long pigtail
cable with WINSTA mini plug
2+PE wiring | 10A

WIELAND GST18



25 cm long pigtail
cable with GST18i3 plug
2+PE wiring | 10A

POWER SUPPLY



cable with standard plug type
a cable length 1,9 to 4,9m) -
not available for all standards

PACKAGE CONTAINS

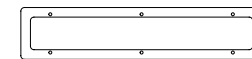

1 x mounting frame for installation

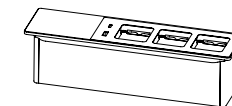

1 x panel with chosen power supply



6 x mounting screws in 6 possible sizes
(depending on the desk mounting height)

FLAT

by panconnect.

SIZE XL

SOCKETS

NUMBER OF SOCKETS: 1-4

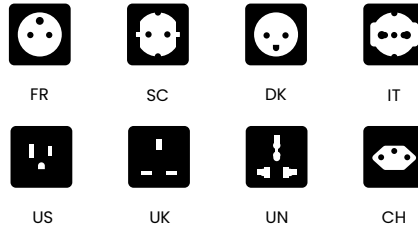

MODULES

NUMBER OF MODULES: 0-3

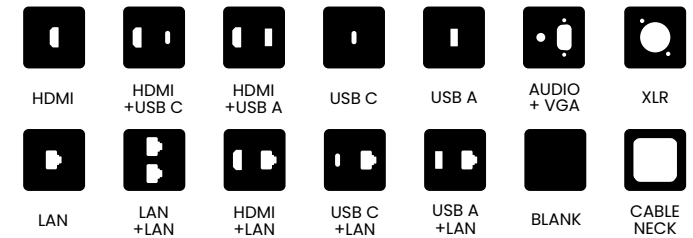

1370 g

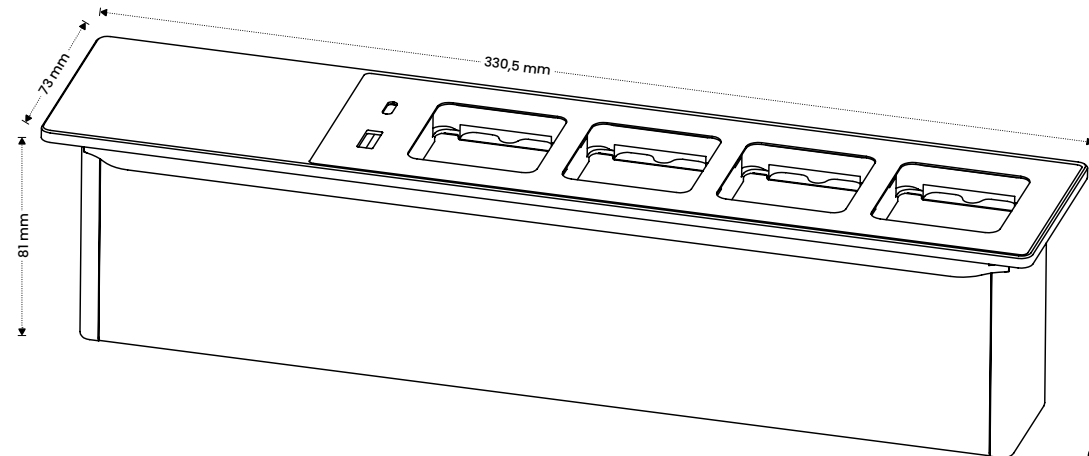

COLOURS



black



white



silver

WIRELESS CHARGING

Qi compliant 1.5A/5V

WITH INTEGRATED Qi

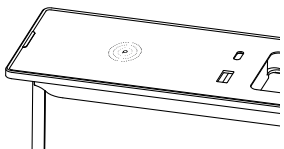

WITHOUT INTEGRATED Qi

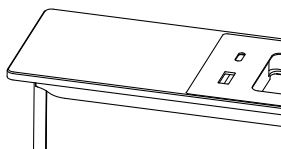

POWER CABLES

WAGO miniWINSTA



25 cm long pigtail
cable with WINSTA mini plug
2+PE wiring | 10A

WIELAND GST18



25 cm long pigtail
cable with GST18i3 plug
2+PE wiring | 10A

POWER SUPPLY



cable with standard plug type
a cable length 1,9 to 4,9m) -
not available for all standards

PACKAGE CONTAINS

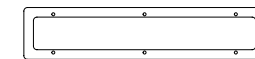

1 x mounting frame for installation

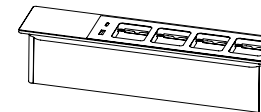

1 x panel with chosen power supply



6 x mounting screws in 6 possible sizes
(depending on the desk mounting height)



FLAT

by panconnect.

PLUS

CONTROL SYSTEM

NEETS



it is ready for easy installation of **standard 55 × 55 mm** control system from Blamp/Neets (BraVo, OsCar, Echo, Sierra)

CUE



it is ready for installation of **small wired 8-button** keypad CUE-55 from CUE systems

OWN INTEGRATION



other **control system up to 55 × 55 mm** size supported. For more information please contact your sales rep.

COLOURS



black



white



silver

WIRELESS CHARGING

Qi compliant 1.5A/5V

WITH INTEGRATED Qi

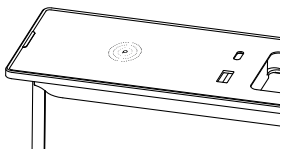

WITHOUT INTEGRATED Qi

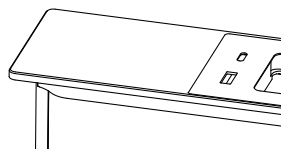

SOCKETS

NUMBER OF SOCKETS: 1-3



FR



SC



DK



IT



US



UK



UN



CH

MODULES

NUMBER OF MODULES: 0-2



HDMI



HDMI + USB C



HDMI + USB A



USB C



USB A



AUDIO + VGA



XLR



LAN



LAN + LAN



HDMI + LAN



USB C + LAN



USB A + LAN



BLANK



CABLE NECK



1740 g

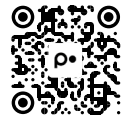
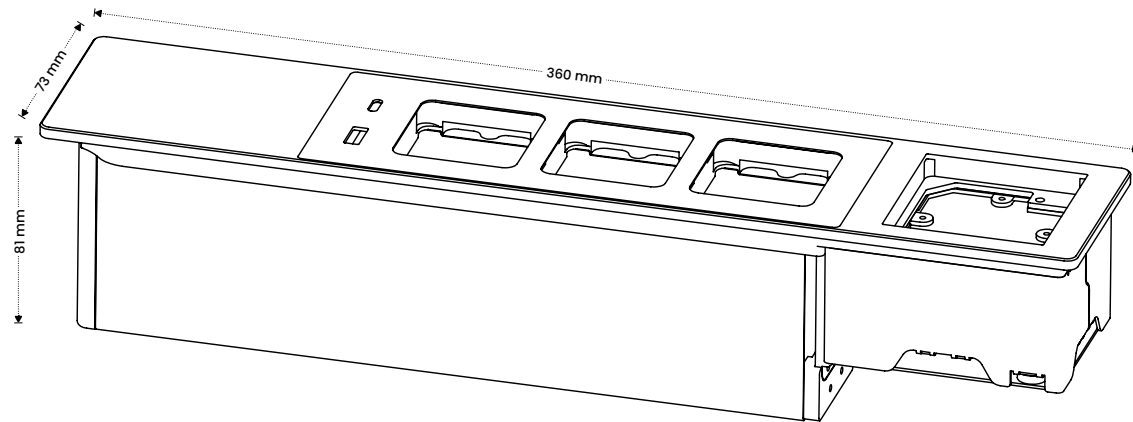

POWER CABLES

WAGO miniWINSTA



25 cm LONG pigtail
cable with WINSTA mini plug
2+PE wiring | 10A

WIELAND GST18



25 cm LONG pigtail
cable with GST18i3 plug
2+PE wiring | 10A

POWER CABLE



cable with standard plug type
a cable length **1,9 to 4,9m** -
not available for all standards

PACKAGE CONTAINS

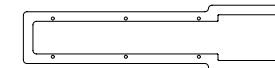

1 × mounting frame for installation

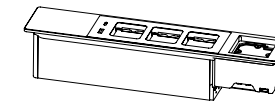

1 × panel with chosen power supply



6 × mounting screws in 6 possible sizes
(depending on the desk mounting height)

MODULES

by panconnect.

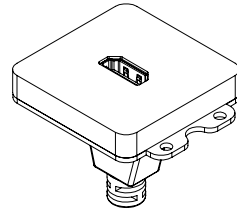

HDMI HDM12.0b

F/F
4K 60HZ
150mm
gold plated
awg32/22
black pvc

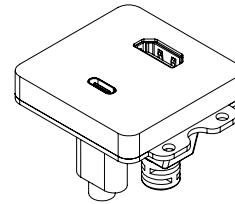

USB-C 3.2 GEN 2

M/F
10Gbps
150mm
gold and nickel plated
black pvc

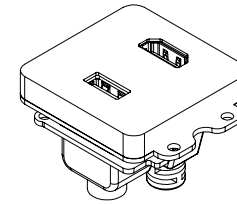

USB-A 3.0 GEN 2

F/F
5Gbps | 135mm
gold and nickel plated
AWG 28/28
black pvc

HDMI HDM12.0b

F/F | 4K 60HZ
150mm | gold plated
awg32/22
black pvc

HDMI HDM12.0b

F/F | 4K 60HZ
150mm | gold plated
awg32/22
black pvc

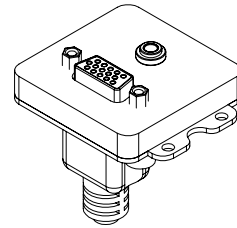

VGA DDC2 and EDID support

F/F
HD
150mm
15pin
black pvc

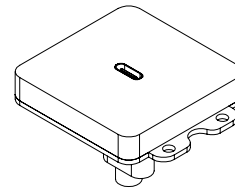

USB-C 3.2 GEN 2

M/F
10Gbps
150mm
gold and nickel plated
black pvc

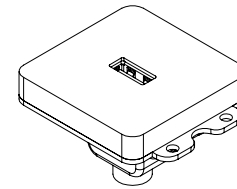

USB-A 3.0 GEN 2

F/F
5Gbps | 135mm
gold and nickel plated
AWG 28/28
black pvc

AUDIO

F/F | 3,5mm jack
3 PIN 0,35mm
150mm
goldplated
black pvc

COLOURS



black



white



silver

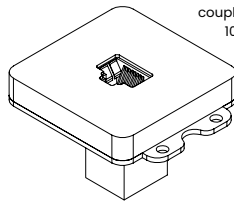

LAN CAT 6A

coupler RJ45 | up to 500MHz,
10GBase-T | Gold-plated
360° shielded
connection
Fully shielded
metal housing

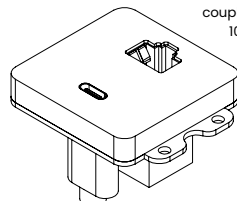

LAN CAT 6A

coupler RJ45 | up to 500MHz,
10GBase-T | Gold-plated
360° shielded
connection
Fully shielded
metal housing

USB-C 3.2 GEN 2

M/F
10Gbps | 150mm
gold and nickel plated
black pvc

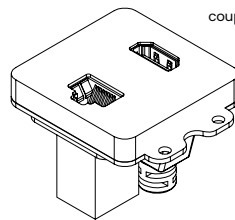

LAN CAT 6A

coupler RJ45 | up to 500MHz,
10GBase-T | Gold-plated
360° shielded
connection
Fully shielded
metal housing

HDMI HDM12.0b

F/F | 4K 60HZ
150mm | gold plated
awg32/22
black pvc

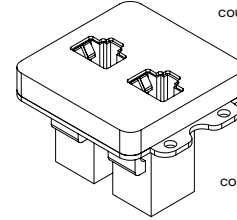

LAN CAT 6A

coupler RJ45 | up to 500MHz,
10GBase-T | Gold-plated
360° shielded
connection
Fully shielded
metal housing

LAN CAT 6A

coupler RJ45 | up to 500MHz,
10GBase-T | Gold-plated
360° shielded
connection | Fully shielded | metal housing

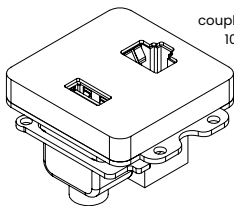

LAN CAT 6A

coupler RJ45 | up to 500MHz,
10GBase-T | Gold-plated
360° shielded
connection
Fully shielded
metal housing

USB-A 3.0 GEN 2

F/F
5Gbps | 135mm
gold and nickel plated
AWG 28/28 | black pvc

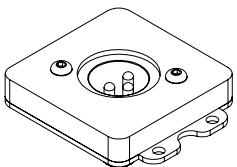

XLR

XLR socket FEMALE
16 A
direct 3pin solder-on
25mm
nickled
Black PLA

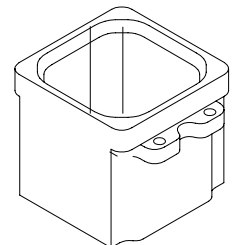

CABLE NECK

pull-out
connector
modul

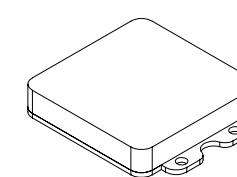

BLANK

PRÁZDNÁ POZICE
PRO PŘÍPADNÉ
POZDĚJŠÍ POUŽITÍ

PULL-OUT SYSTEM

by panconnect•

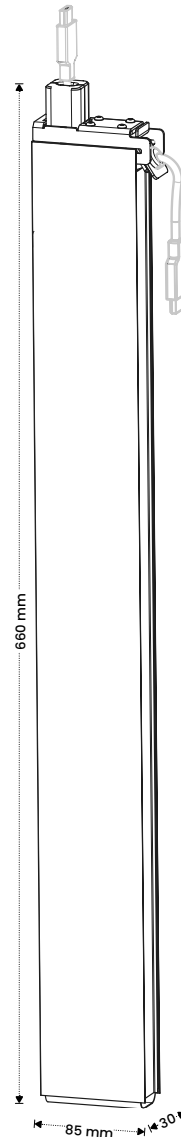

PULL-OUT - mechanism that works on the principle of gravity weighted cables in a textile bag and it allows the cable to be pulled up to 96 cm (the total length of the cable is 200 cm).

WEIGHT

SIZE S

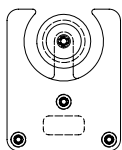

260 g

SIZE M

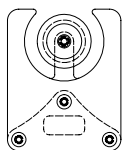

360 g

SIZE L

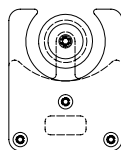

460 g

PACKAGE CONTAINS:



1 x pull-out system

CABLES

NUMBER OF CABLES:

1-2

USB-C 3.2 (M-M)

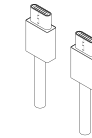

USB-C 3.2 gen 1
5Gbps | 200cm
gold and nickel plated
black pvc

USB-C 3.2 (M-F)

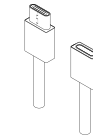

USB-C 3.2 gen 1
5Gbps | 200cm
gold and nickel plated
black pvc

USB-C (M) / HDMI (M)

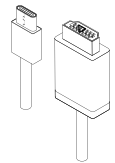

HDMI2.0 | 4K60Hz
200cm
gold-plated
AWG32 / 22 | black pvc

mini DISPLAY PORT (M) / HDMI (M)

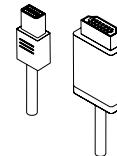

DP | 4K30Hz
200cm
4K/UHD/2160p@60Hz
black pvc

DISPLAY PORT (M-M)

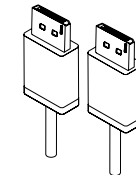

DPI.4 | 8K60Hz
200cm
gold-plated
AWG32 / 22 | black pvc

DISPLAY PORT (M) / HDMI (M)

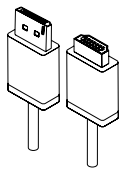

2K DP | WUXGA (1920x1200)
200cm
SECURE LOCK | gold-plated
AWG28 | black pvc

HDMI (M-M)

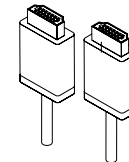

HDMI1.4 | 4K30Hz
200cm
gold-plated | AWG32 / 22
black pvc

HDMI (M-F)

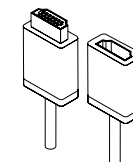

HDMI1.4 | 4K30Hz
200cm
gold-plated | AWG32 / 22
black pvc

USB 3.0 (M-F)

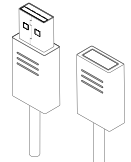

USB3.0 | 5Gbps
200cm
9pin
AWG28/28 | black pvc

LAN (M-M)

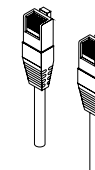

CAT6 RJ45 | UTP
200cm
CU 4x2
AWG26/7 | black pvc

SAFETY & RECYCLATION



PANCONNECT declares that panel CORD complies with Low voltage directive 2014/35/EC and EMC directive 2014/30/EU. Testing has been made according to EN 50491-5-1:2010 and EN 50491-5-2:2010 standards.



All products from PANCONNECT are intended for **upgrade** or **recyclation** in accordance with the company's policy.



Before the disposal of this panel comes up, please verify if this product can or cannot be upgraded or overhauled. If it's not possible, kindly arrange the disposal in accordance with valid EU directives. This product belongs to WASTE ELECTRICAL AND ELECTRONIC EQUIPMENT (WEEE) category so the disposal is possible only in accordance with this WEEE Directive 2012/19/EU. It cannot be part of the municipal waste.

For more information please check
www.asekol.cz | info@asekol.cz

INSTALLATION MANUAL



Easy installation

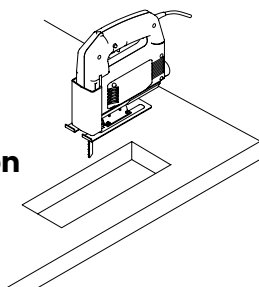

DESK MOUNTING HEIGHT

10 mm
to 40 mm
(up to 60mm with custom screws)

Tools: jig saw, drill and bit Ø 10mm

- 01| Mark 4 holes according to the cutout and drill them with the bit
- 02| Take a jig saw and cut the holes
- 03| Put the panel to the hole and place the metal frame over the bottom part of the panel and tighten the screws
- 04| If you've chosen pull-out system for your panel, add it now

USB-C SPECIFICATION

PowerDelivery up to 60W

USB-A SPECIFICATION

QuickCharge 3.0 up to 5A

SOCKETS

230V/10A (EU), 110V/10A (US)

INGRESS PROTECTION

IP22

POWER SUPPLY

110 - 250V, 10A

MODULARITY

MODULES | PASS-THRU | PULL-OUT

MATERIALS

Dural | stainless steel | FENIX NTM | cortexin

DESIGNER

Dominik Hutečka

Designed & manufactured in Brno, Czech Republic.
PANCONNECT s.r.o. | Olomoucká 51, Brno | Czech Republic
www.panconnect.eu | support@panconnect.eu

panconnect