

SNOOK

by panconnect•

SNOOK is a panel that combines pure design and effective connectivity. You can choose from **2 sizes** of this panel - **M** and **L** in 15 colour combinations.

SNOOK M contains a charging part with USB-A and USB-C slots (**60 W**) and full-fledged wireless Qi charging. There is also an integrated part for two pull - out cables.

SNOOK L profits from all parts of **SNOOK M** but has an extra socket. Great benefit is that **USB-A and USB-C** slots can be placed on the

bottom or upper part of the panel and it allows direct connection of **USB-A and USB-C** charging cables.

For manipulation with audio-video or charging cables can be used a **PULL-OUT** system that works on principle of gravity weighted cables in a textile bag and it allows to pull out the **cable up to 96 cm** (total length of the cable is 200 cm).

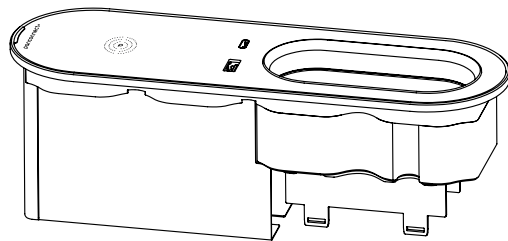

Size M

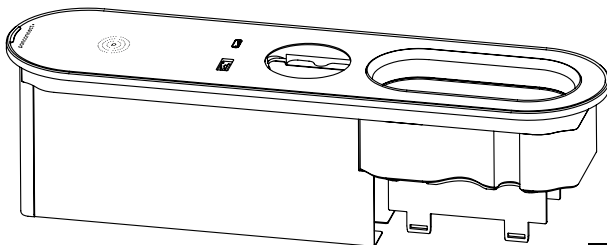

Size L

DIMENSIONS	WEIGHT	NO. OF SOCKETS	PULL-OUT CABLE SYSTEM	DIMENSIONS WITH PULL-OUT CABLE SYSTEM
------------	--------	----------------	-----------------------	---------------------------------------

227,5 × 73 × 81 mm

1020 g

0

2

227,5 × 73 × 690 mm

279 × 73 × 81 mm

1200 g

1

2

279 × 73 × 690 mm

SNOOK

by panconnect•

SIZE M

COLOURS



FRAME COLOUR



INLAY COLOUR



URBAN
TAUPE



ARGENT
SILVER



DARK
CHARCOAL



NERO
INGO



NERO
INGO



NERO
INGO



BLU FES



BLU FES

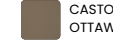

CASTORO
OTTAWA



GRIGIO
EFESO

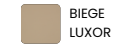

BIEGE
LUXOR



BIANCO
DOVER



1020 g

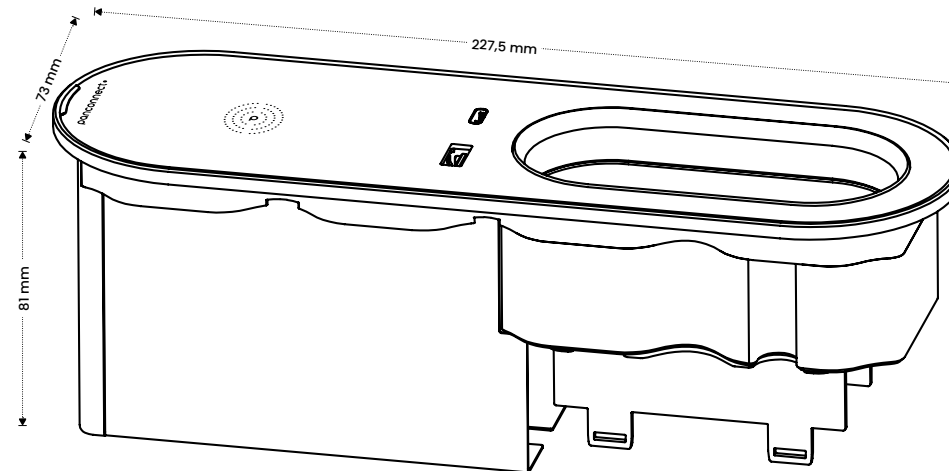

POWER CABLES

**WAGO
miniWINSTA**



25 cm long pigtail
cable with WINSTA mini plug
2+PE wiring | 10A

**WIELAND
GST18**



25 cm long pigtail
cable with GST18i3 plug
2+PE wiring | 10A

**POWER
SUPPLY**



cable with the schuko
plug type
and length of the cable 3 m

CHARGING POSSIBILITIES

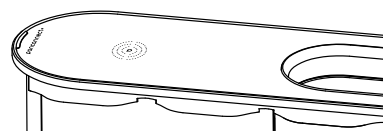

**USB-C and USB-A charging
placed in the bottom part
of the panel**

**USB-A
QUICK CHARGE**
USB 3.0
5Gbps

**USB-C
POWER DELIVERY**
USB-C 3.2 gen 1
5Gbps

VIEW FROM THE BOTTOM PART OF
THE PANEL

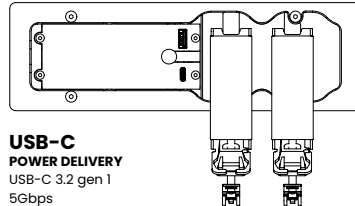

**USB-C and USB-A
charging in the upper
part of the panel**

**USB-A
QUICK CHARGE**
USB 3.0
5Gbps

**USB-C
POWER DELIVERY**
USB-C 3.2 gen 1
5Gbps

PACKAGE CONTAINS

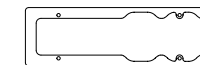

1 × mounting frame for installation

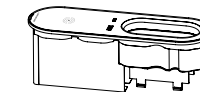

1 × panel with chosen power supply



6 × mounting screws in 6 possible sizes (de-
pending on the the desk mounting height)

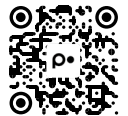

SNOOK

by panconnect•

SIZE L

SOCKETS

NUMBER OF SOCKETS: 1

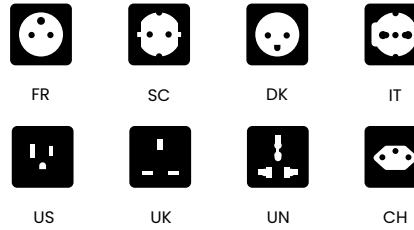

COLOURS



FRAME COLOUR



INLAY COLOUR



1200 g

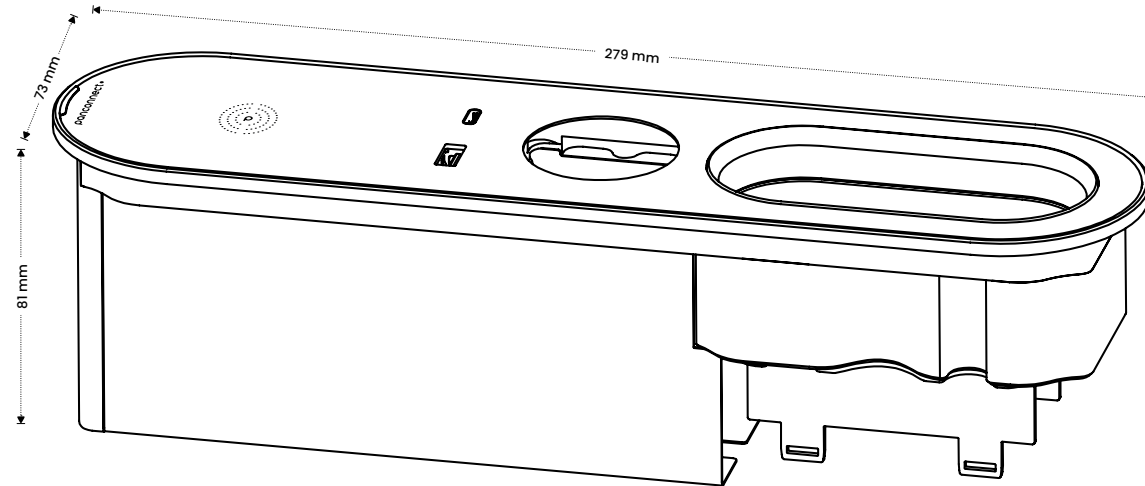

POWER CABLES

WAGO miniWINSTA



25 cm long pigtail cable with WINSTA mini plug 2+PE wiring | 10A

WIELAND GST18



25 cm long pigtail cable with GST18i3 plug 2+PE wiring | 10A

POWER SUPPLY



25 cm long cable with the schuko plug type and length of the cable 3 m

CHARGING POSSIBILITIES

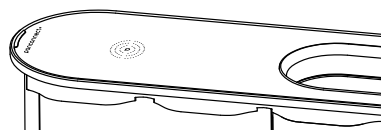

USB-C and USB-A charging placed in the bottom part of the panel

USB-A QUICK CHARGE
USB 3.0
5Gbps

USB-C POWER DELIVERY
USB-C 3.2 gen 1
5Gbps

VIEW FROM THE BOTTOM PART OF THE PANEL

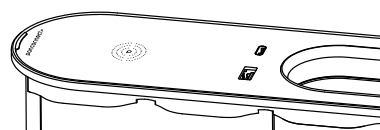
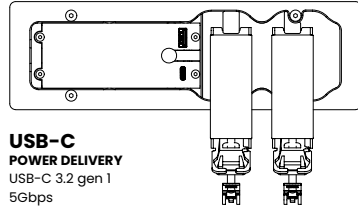

USB-C and USB-A charging in the upper part of the panel

USB-A QUICK CHARGE
USB 3.0
5Gbps

USB-C POWER DELIVERY
USB-C 3.2 gen 1
5Gbps

PACKAGE CONTAINS

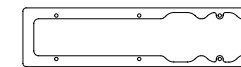

1 × mounting frame for installation

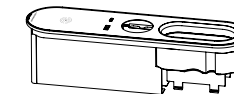

1 × panel with chosen power supply

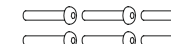

6 × mounting screws in 6 possible sizes (depending on the desk mounting height)



PULL-OUT SYSTEM

by panconnect•

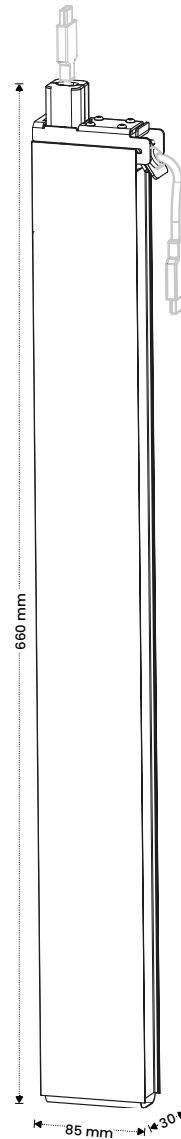

PULL-OUT - mechanism that works on the principle of gravity weighted cables in a textile bag and it allows the cable to be pulled up to 96 cm (the total length of the cable is 200 cm).

SNOOK always contains 2 pull-outs in the package.

WEIGHT

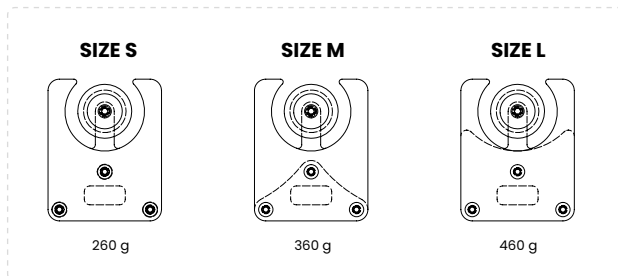

PACKAGE CONTAINS

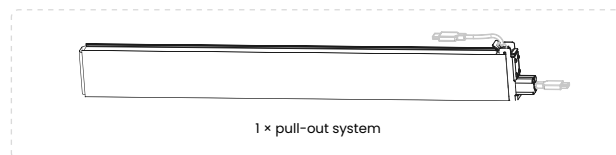

CABLES

USB-C 3.2 (M-M)

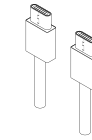

USB-C 3.2 gen 1
5Gbps | 200cm
gold and nickel plated
black pvc

USB-C 3.2 (M-F)

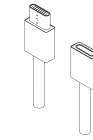

USB-C 3.2 gen 1
5Gbps | 200cm
gold and nickel plated
black pvc

USB-C 3.2 (M) / HDMI (M)

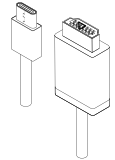

HDMI2.0 | 4K60Hz
200cm
gold-plated
AWG32 / 22 | black pvc

mini DISPLAY PORT (M) / HDMI (M)

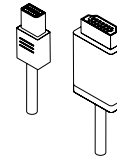

DP | 4K30Hz
200cm
4K/UHD/2160p@60Hz
black pvc

DISPLAY PORT (M-M)

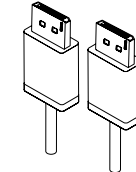

DPI.4 | 8K60Hz
200cm
gold-plated
AWG32 / 22 | black pvc

DISPLAY PORT (M) / HDMI (M)

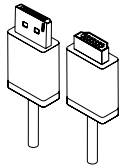

2K DP | WUXGA (1920x1200)
200cm
SECURE LOCK | gold-plated
AWG28 | black pvc

HDMI (M-M)

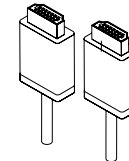

HDMI1.4 | 4K30Hz
200cm
gold-plated | AWG32 / 22
black pvc

HDMI (M-F)

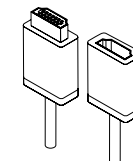

HDMI1.4 | 4K30Hz
200cm
gold-plated | AWG32 / 22
black pvc

USB 3.0 (M-F)

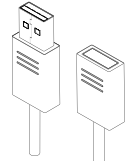

USB3.0 | 5Gbps
200cm
9pin
AWG28/28 | black pvc

LAN (M-M)

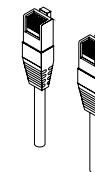

CAT6 RJ45 | UTP
200cm
CU 4x2
AWG26/7 | black pvc

USB-A 2.0 (M) / LIGHTNING

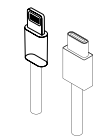

200cm
nickel-alu plated
black pvc

USB-C 2.0 (M) / LIGHTNING (M)

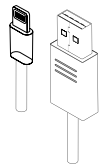

200cm
nickel-alu plated
black pvc

SAFETY & RECYCLATION



PANCONNECT declares that panel CORD complies with Low voltage directive 2014/35/EC and EMC directive 2014/30/EU. Testing has been made according to EN 50491-5-1:2010 and EN 50491-5-2:2010 standards.



All products from PANCONNECT are intended for **upgrade** or **recyclation** in accordance with the company's policy.



Before the disposal of this panel comes up, please verify if this product can or cannot be upgraded or overhauled. If it's not possible, kindly arrange the disposal in accordance with valid EU directives. This product belongs to WASTE ELECTRICAL AND ELECTRONIC EQUIPMENT (WEEE) category so the disposal is possible only in accordance with this WEEE Directive 2012/19/EU. It cannot be part of the municipal waste.

For more information please check
www.asekol.cz | info@asekol.cz

INSTALLATION MANUAL

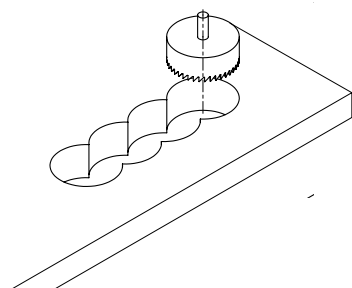

DESK MOUNTING HEIGHT

10 mm
up to 40 mm
(up to 60mm
with custom screws)

Tools: Hole saw, rasp

Warning: Always follow the cutout for your panel. Steps may vary depending on the panel.

- 01| Mark the centers and cut out the holes with the hole saw
- 02| Clean sharp edges with the rasp and put the panel into the cutout.
- 03| Insert the frame from the bottom of the panel and tighten the screws.
Clip on the pull out from the bottom part of the panel.

USB-C SPECIFICATION

PowerDelivery up to 60W

USB-A SPECIFICATION

QuickCharge 3.0 up to 5A

SOCKETS

230V/10A (EU), 110V/10A (US)

INGRESS PROTECTION

IP22

POWER SUPPLY

110 - 250V, 10A

MODULARITY

PULL-OUT

MATERIALS

Dural | stainless steel | FENIX NTM | cortexin

DESIGNER

Dominik Hutečka

Designed & manufactured in Brno, Czech Republic.
PANCONNECT s.r.o. | Olomoucká 51, Brno | Czech Republic
www.panconnect.eu | support@panconnect.eu

panconnect